

LI-7820 N₂O/H₂O Trace Gas Analyzer Instruction Manual



LI-COR®

LI-7820 N₂O/H₂O

Trace Gas Analyzer

Instruction Manual

LI-COR Biosciences

4647 Superior Street
Lincoln, Nebraska 68504
Phone: +1-402-467-3576
Toll free: 800-447-3576 (U.S. and Canada)
envsales@licor.com

Regional Offices

LI-COR Biosciences GmbH

Siemensstraße 25A
61352 Bad Homburg
Germany
Phone: +49 (0) 6172 17 17 771
envsales-gmbh@licor.com

LI-COR Biosciences UK Ltd.

St. John's Innovation Centre
Cowley Road
Cambridge
CB4 0WS
United Kingdom
Phone: +44 (0) 1223 422102
envsales-UK@licor.com

LI-COR Distributor Network:

www.licor.com/envdistributors

LI-COR[®]

Notice

The information in this document is subject to change without notice.

LI-COR MAKES NO WARRANTY OF ANY KIND WITH REGARD TO THIS MATERIAL, INCLUDING BUT NOT LIMITED TO THE IMPLIED WARRANTIES OF MERCHANTABILITY AND FITNESS FOR A PARTICULAR PURPOSE. LI-COR shall not be held liable for errors contained herein or for incidental or consequential damages in connection with the furnishing, performance, or use of this material.

This document contains proprietary information, which is protected by copyright. All rights are reserved. No part of this document may be photocopied, reproduced, or translated to another language without prior written consent of LI-COR, Inc.

Microsoft, Windows, and Excel are registered trademarks of the Microsoft Corporation. Wi-Fi is a trademark of the Wi-Fi Alliance. Swagelok® is a registered trademark of the Swagelok Company. All other trademarks and registered trademarks are property of their respective owners.

This product is protected by U.S. patents 8,659,758, 8,665,442, 8,885,167, 9,116,047, 9,194,742, 9,304,080, 9,581,492, 9,678,003, 9,759,654, 9,759,655, 9,989,729, and 10,060,942. Additional patents pending in the U.S. and other countries.

Printing History





© Copyright 2020, LI-COR, Inc. All rights reserved.

Publication Number: 984-19432

Created on: Monday, March 6, 2023.

Notes on Safety

This LI-COR product has been designed to be safe when operated in the manner described in this manual. The safety of this product cannot be assured if the product is used in any other way than is specified in this manual. The product is intended to be used by qualified personnel. Read this entire manual before using the product.

| Equipment markings: | |
|---|---|
|  | The product is marked with this symbol when it is necessary for you to refer to the manual or accompanying documents in order to protect against injury or damage to the product. |
|  | The product is marked with this symbol when a hazardous voltage may be present. |
|  | The product is marked with this symbol if a Chassis Ground connection is required. |
|  | The product is marked with this symbol to indicate that a direct current (DC) power supply is required. |
| WARNING | Warnings must be followed carefully to avoid bodily injury. |
| CAUTION | Cautions must be observed to avoid damage to your equipment. |
| Manual markings: | |
| Warning | Warnings must be followed carefully to avoid bodily injury. |
| Caution | Cautions must be observed to avoid damage to your equipment. |
| Note | Notes contain important information and useful tips on the operation of your equipment. |

CE Marking:

This product is a CE-marked product. For conformity information, contact LI-COR Support at envsupport@licor.com. Outside of the U.S., contact your local sales office or distributor.

Maximum power and frequency specifications (Europe ETSI).

| RF band | Peak Antenna Gain | Technology | Maximum transmit power at antenna connector | Frequencies |
|---------|-------------------|------------|---|--|
| 2.4 GHz | 2.5 dBi | WLAN | 55.8 mW (+17.5 dBm) | [BW 20 MHz] x 13 overlapping channels, # (center freq. MHz): * [2400 - 2483.5 MHz]: 1 (2412), 2 (2417), 3 (2422), 4 (2427), 5 (2432), 6 (2437), 7 (2442), 8 (2447), 9 (2452), 10 (2457), 11 (2462), 12 (2467), 13 (2472) |
| | | | | [BW 40 MHz] x 9 overlapping channels, # (center freq. MHz): * [2400 - 2483.5 MHz]: 3 (2422), 4 (2427), 5 (2432), 6 (2437), 7 (2442), 8 (2447), 9 (2452), 10 (2457), 11 (2462) |
| 5 GHz | 4.6 dBi | | 22.3 mW (+13.5 dBm) | [BW 20 MHz] x 21 non-overlapping channels, # (center freq. MHz): * [5150 - 5250 MHz]: 36 (5180), 40 (5200), 44 (5220), 48 (5240) * [5250 - 5350 MHz]: 52 (5260), 56 (5280), 60 (5300), 64 (5320) * [5470 - 5725 MHz]: 100 (5500), 104 (5520), 108 (5540), 112 (5560), 116 (5580), 132 (5660), 136 (5680), 140 (5700) |
| | | | 7.9 mW (+9 dBm) | * [5725 - 5850 MHz]: 149 (5745), 153 (5765), 157 (5785), 161 (5805), 165 (5825) |
| | | | 22.3 mW (+13.5 dBm) | [BW 40 MHz] x 9 non-overlapping channels, # (center freq. MHz): * [5150 - 5250 MHz]: 38 (5190), 46 (5230) * [5250 - 5350 MHz]: 54 (5270), 62 (5310) * [5470 - 5725 MHz]: 102 (5510), 110 (5550), 134 (5670) |
| | | | 7.9 mW (+9 dBm) | * [5725 - 5850 MHz]: 151 (5755), 159 (5795) |
| | | | 22.3 mW (+13.5 dBm) | [BW 80 MHz] x 4 non-overlapping channels, # (center freq. MHz): * [5150 - 5250 MHz]: 42 (5210) * [5250 - 5350 MHz]: 58 (5290) * [5470 - 5725 MHz]: 106 (5530) |
| | | | 7.9 mW (+9 dBm) | * [5725 - 5850 MHz]: 155 (5775) |

California Proposition 65 Warning



Warning: *This product can expose you to chemicals including Nickel, which is known to the State of California to cause cancer. For more information go to www.P65Warnings.ca.gov.*

Federal Communications Commission Radio Interference Statement

WARNING: This equipment generates, uses, and can radiate radio frequency energy and if not installed in accordance with the instruction manual, may cause interference to radio communications. It has been tested and found to comply with the limits for a Class A computing device pursuant to Subpart J of Part 15 of FCC rules, which are designed to provide a reasonable protection against such interference when operated in a commercial environment. Operation of this equipment in a residential area is likely to cause interference in which case the user, at his own expense, will be required to take whatever measures may be required to correct the interference.

Waste Electronic and Electrical Equipment (WEEE) Notice

This symbol indicates that the product is to be collected separately from unsorted municipal waste. The following applies to users in European countries: This product is designated for separate collection at an appropriate collection point. Do not dispose of as household waste. For more information, contact your local distributor or the local authorities in charge of waste management.



Wi-Fi Warning

When powered on for the first time, this device will broadcast a wireless local area network (WLAN) signal. The use of WLAN is restricted in some regions and countries, and the illegal use of WLAN may be punishable under these regulations. Check your local regulations to determine if WLAN is permitted.

If WLAN is not permitted in your area, it is your responsibility to disable the WLAN signal. LI-COR, Inc. cannot be held liable for any problems arising from the use of WLAN in any countries or regions where it is not permitted. Legal penalties may result from failing to disable or re-enabling the wireless network where it is not permitted, modifying or altering the product, or removing the certification labels from the product.

Instructions for disabling the WLAN signal are provided in this manual.

Preface

This document provides basic operating instructions for the LI-7820 gas analyzer running software version 2.3. .

We strive to ensure that this document accurately represents the instrument. As with any software-dependent instrument, development continues after the documentation goes to press. As a result, small inconsistencies between the documentation and the instrument may be present.

Updates to this document, as well as application notes, technical literature, videos that support the product, and software updates, will be available from licor.com/env/support (search for LI-7820).

We appreciate feedback on this manual. Send your comments to envfeedback@licor.com.

For technical support with the product, go to licor.com/env/support or email envsupport@licor.com.

Contents

| | |
|---------------|---|
| Preface | v |
|---------------|---|

Section 1. Introduction to the LI-7820

| | |
|-------------------------------|-----|
| What's what | 1-1 |
| Gas analyzer | 1-1 |
| Rechargeable batteries | 1-3 |
| Universal power adapter | 1-3 |
| Ethernet cable | 1-4 |
| Accessory kit | 1-5 |
| Optional accessories | 1-5 |
| Reduced flow rate kit | 1-5 |
| Auxiliary power cable | 1-5 |
| Backpack kit | 1-5 |

Section 2. Getting started

| | |
|--|------|
| Powering on the instrument | 2-1 |
| Power options | 2-2 |
| Universal power adapter | 2-2 |
| Rechargeable batteries | 2-2 |
| External power source | 2-3 |
| Connecting with the instrument | 2-4 |
| Connecting over wireless | 2-5 |
| Connecting over a wired network | 2-6 |
| Enabling and disabling Wi-Fi | 2-8 |
| Instrument display | 2-9 |
| Status codes | 2-10 |
| Powering off the instrument | 2-11 |
| Storing the instrument | 2-12 |
| Shipping the instrument | 2-12 |
| Important note on shipping lithium ion batteries | 2-12 |
| Shipping batteries with equipment | 2-13 |
| Shipping batteries without equipment (2 or less) | 2-13 |
| Shipping batteries without equipment (3 to 10) | 2-13 |
| Notes | 2-14 |

Section 3. Applications of the LI-7820

| | |
|---|------|
| Flow schematic | 3-1 |
| Soil gas flux measurements | 3-2 |
| Connecting the air inlet and outlet | 3-2 |
| Plumbing a subsample | 3-3 |
| Configuration options | 3-4 |
| Standard | 3-4 |
| Reduced flow rate | 3-4 |
| High altitude | 3-9 |
| Retrieving data from the instrument | 3-9 |
| Downloading a data file | 3-9 |
| Components of the data file | 3-11 |
| Installing the instrument in a rack mount | 3-13 |

Section 4. Software overview

| | |
|-------------------------------------|------|
| Home page | 4-1 |
| Indicators and buttons | 4-2 |
| Remarks | 4-2 |
| Graphs | 4-3 |
| Settings | 4-4 |
| Software | 4-4 |
| Time | 4-6 |
| Network | 4-7 |
| Wi-Fi | 4-8 |
| LI-8100/A | 4-9 |
| Calibration | 4-10 |
| Diagnostics | 4-11 |
| Power | 4-11 |
| Performance status indicators | 4-11 |
| Diagnostic log | 4-12 |
| Performance monitor | 4-12 |
| Operating information | 4-13 |
| Layouts | 4-14 |
| Thresholds | 4-15 |
| Export | 4-15 |

Section 5. Troubleshooting

| | |
|---|-----|
| Connection problems | 5-1 |
| Request to connect to instrument network rejected by Android OS | 5-1 |
| Request to connect to instrument network rejected by iOS | 5-1 |
| Other wireless connection problems | 5-2 |
| Unable to connect with the instrument over a wired connection | 5-3 |
| Measurement problems | 5-5 |
| Readings drift or step change unexpectedly | 5-5 |

| | |
|--|-----|
| Pressure readings are questionable or unstable | 5-5 |
| Gas density measurements appear to have oscillations | 5-5 |
| Interface issues | 5-6 |
| The interface is in a language that I don't understand | 5-6 |
| Graphed data overlaps in time or has gaps | 5-6 |
| Status and warning messages | 5-7 |
| Code 128 triggered | 5-7 |

Section 6. Maintenance

| | |
|---|-----|
| Instrument calibration | 6-1 |
| Setting the N2O span and zero | 6-2 |
| Recovering from a bad calibration | 6-3 |
| Replacing the air inlet filter | 6-4 |
| Replacing the purge dry-down chemical | 6-5 |
| Software updates | 6-7 |

Section 7. Communication with the MQTT protocol

| | |
|---|------|
| Terminology | 7-1 |
| Basic commands in a terminal program | 7-2 |
| Streaming data into the interface | 7-3 |
| Setting the zero calibration | 7-4 |
| Setting the span calibration | 7-5 |
| Rebooting the instrument | 7-6 |
| Powering off the instrument | 7-6 |
| Basic commands with a Python script | 7-7 |
| Configuring paho-mqtt in Windows | 7-7 |
| Configuring paho-mqtt in Mac or Linux | 7-7 |
| Streaming data into the Terminal Program | 7-8 |
| Downloading data in a date and time range | 7-9 |
| Additional commands | 7-10 |

Appendix A. Measurement overview

Appendix B. Additional safety information

Appendix C. Specifications

Standard Terms and Conditions

Index

Section 1.

Introduction to the LI-7820

The LI-7820 N₂O/H₂O Trace Gas Analyzer is a high-precision, high-stability, laser-based gas analyzer that uses Optical Feedback — Cavity-Enhanced Absorption Spectroscopy (OF-CEAS) to measure gases in air. OF-CEAS is a well-established spectroscopic technique that is described in published literature. The analyzer reports and stores in its internal memory N₂O dry mole fractions in air corrected for both the spectroscopic interferences and dilution due to H₂O. See *Measurement overview* on page A-1 for a brief summary of OF-CEAS.

What's what

If you have just taken delivery of the instrument, check your packing list to be sure you received everything that you ordered. The LI-7820 includes some or all of the following components.

Gas analyzer



The gas analyzer is in a gray enclosure. It is designed for indoor and outdoor use but it is not waterproof.

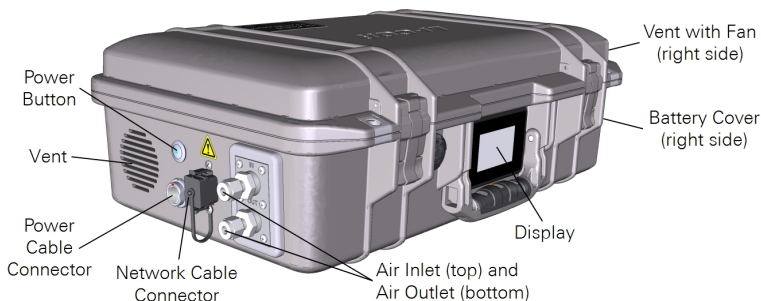

The analyzer should not be allowed to sit in standing water, exposed to driving rain, or deployed outdoors without weather protection. ***Use caution to avoid drawing water into the analyzer air inlet!*** Although equipped with software protection that disables the pump if a clog is detected (such as the filter becoming wet and stopping air flow), if water is drawn into the inlet the instrument will have to be repaired at the factory.

Power button

The power button is used to power the instrument on and off and enter and exit sleep mode. It has an indicator light that will be illuminated when the instrument is powered on and dark when it is powered off. Functions of the button are described in *Powering on the instrument* on page 2-1 and *Powering off the instrument* on page 2-11.

Power cable connector

The power cable connector on the instrument is compatible with the universal power adapter (part number 9968-232) and the optional DC power cable (part number 9968-242). See *Power options* on page 2-2.



Warning: Use the safety-approved power cord supplied with the instrument. The instrument power supply is equipped with a 3-wire grounding plug. This plug will only fit into a grounded outlet. Do not defeat the purpose of the grounding-type plug. Do not place the instrument where the power cord will be walked on or exposed to water or chemical spills.

Avertissement: Utilisez le cordon d'alimentation approuvé pour la sécurité fourni avec l'instrument. L'alimentation de l'instrument est équipée d'une fiche de terre à 3 fils. Cette fiche ne rentrera que dans une prise de terre. N'allez pas à l'envers de la fonction de la fiche de mise à la terre. Ne placez pas l'instrument où le cordon d'alimentation sera piétiné ou exposé à l'eau ou aux déversements de produits chimiques.

Network cable connector

The network cable connector is compatible with standard RJ-45 Ethernet cables.

Air inlet

The instrument draws air in through the inlet using the internal pump. The inlet connector is a compression fitting, which is compatible with ¼" outside diameter

tubes. Additional nuts and ferrule sets are include in the accessories kit.



Warning: Do not exceed the maximum absolute pressure rating of 110 kPa.

Advertissement: Ne dépassez pas la pression nominale absolue maximale de 110 kPa.

Air outlet

The instrument exhausts sample air through the outlet. Do not substantially restrict or apply a vacuum to the outlet.

Rechargeable batteries

Part Number
442-11807

Two batteries are provided with the instrument. We recommend leaving at least one battery in the instrument when you are using it. The batteries are 14.4 V lithium ion battery packs with 6.8 amp-hour capacity. Two batteries can provide up to 8 hours of operation under most conditions. Batteries are shipped in a partially discharged state. They should be fully charged prior to the first use. Storing the batteries in a discharged state can result in damage to the batteries. Batteries that are installed in the instrument will be charged when the instrument is powered though the universal power adapter.



Warning: Lithium ion batteries may cause environmental damage or damage to human health if they are disposed of improperly. Do not dispose of the batteries in unsorted municipal waste or an incinerator. Many localities have battery recycling facilities that will accept lithium ion batteries. Check your local regulations to determine how to safely dispose of the batteries.

Advertissement: Les batteries lithium ion peuvent causer des dommages à l'environnement ou endommager la santé humaine si l'on se débarrasse d'elles de manière inappropriée. Ne vous débarrassez pas des batteries dans des déchets municipaux non triés ou dans un incinérateur. Plusieurs localités ont des installations de recyclage de batteries qui accepteront les batteries lithium ion. Vérifiez vos réglementations locales pour déterminer comment se débarrasser des batteries en toute sécurité.

Universal power adapter

Part Number
9968-232

The universal power adapter is an AC-to-DC adapter that powers the instrument and charges the batteries when it is plugged into an AC power outlet. The power adapter provides 24 VDC (9.17 amps maximum; 220 watts maximum). It is compatible with

100 to 240 VAC, 50 to 60 Hz. The instrument will include one of the cords listed in *Table 1-1* below. The power adapter and cord are for indoor use; they are not rated for outdoor deployment.

Table 1-1. Power cables for the power adapter.

| Description | Part Number |
|---|-------------|
| For USA, Canada, Mexico, and Japan; NEMA 5-15; Type B | 390-00787 |
| For Europe, South America, and Asia; CEE 7/7; Type C | 390-01486 |
| For United Kingdom; Type G | 390-03089 |
| For Israel; SI32; Type H | 390-03059 |
| For Australia; Type I | 390-03095 |



Warning: Use the safety-approved power cord supplied with the instrument. The instrument power supply is equipped with a 3-wire grounding plug. This plug will only fit into a grounded outlet. Do not defeat the purpose of the grounding-type plug. Do not place the instrument where the power cord will be walked on or exposed to water or chemical spills.

Avertissement: Utilisez le cordon d'alimentation approuvé pour la sécurité fourni avec l'instrument. L'alimentation de l'instrument est équipée d'une fiche de terre à 3 fils. Cette fiche ne rentrera que dans une prise de terre. N'allez pas à l'envers de la fonction de la fiche de mise à la terre. Ne placez pas l'instrument où le cordon d'alimentation sera piétiné ou exposé à l'eau ou aux déversements de produits chimiques.

Ethernet cable

Part Number
616-06116

Network cable with RJ-45 connectors (Cat5e); to connect the instrument to a computer or network. Length of 2.1 meters (7 feet).

Note: Do not use cables other than the one provided. Other cables may result in improper electrical performance.

Accessory kit

Part Number
9978-195

The accessory kit includes some accessories and replacement components that may be useful to you. Additional replacement parts are available from LI-COR or your local distributor.

| Description | Quantity | Part Number |
|--|----------|-------------|
| Replacement dry-down chemical pack (17 grams each) | 3 | 622-17627 |
| Stainless Steel Screws ; M3×0.5; 8 mm | 6 | 150-14419 |
| O-ring; 27×1.5 mm | 2 | 192-16956 |
| O-ring; 22×2.5 mm | 4 | 192-17345 |
| Stainless Steel 1/4" Ferrule and Nut Set | 5 | 300-15025 |
| Filter support disks | 2 | 9878-280 |
| Filter pack; 2-micron (10 filters) | 1 | 9978-234 |

Optional accessories

In addition to the items already mentioned, the analyzer may include the following accessories.

Reduced flow rate kit

Part Number
7800-112

The reduced flow rate adapter is an accessory for the analyzer that, when installed, enables the analyzer to operate at a nominal flow rate of 70 sccm, rather than the standard nominal flow rate of 250 sccm.

Auxiliary power cable

Part Number
9968-242

This optional component allows you to power the instrument from an external DC power supply, such as a deep cycle battery. It has a connector for the instrument power connection and bare leads for a power source. Power requirements are given in *External power source* on page 2-3.

Backpack kit

Part Number
6578-380

The backpack kit is an optional accessory that can be used to carry the instrument. It features a padded back and padded shoulder straps with a padded waist strap and chest strap to help support the instrument as you carry it.



The analyzer is secured in the backpack with several straps. The bottom of the instrument will be against your back. The tubes can face up or down. Use caution with the backpack kit:

- Close the clasps and tighten the straps so that the instrument is secure.
- Do not block the vents or set the instrument in standing water.
- If you are unable to lift the backpack kit comfortably or tighten the straps, consider enlisting the help of a "strapping" assistant.
- Clip the chest and waist straps. Tighten all of the straps snugly.

Section 2.

Getting started

This section provides basic operating instructions for the instrument.

Powering on the instrument

To power on the instrument, either install a battery and push the power button or connect the instrument to an external power supply. The instrument will power on any time power is supplied through the AC power adapter or the auxiliary power cable. See *Power options* on the next page for more details.

If main power is lost, the instrument will run until the batteries are depleted and then it will power off. When the main power is restored, the instrument will power up and the batteries will resume charging (only if powered through the universal power adapter). When powered by batteries only, you must press the power button to turn on the instrument.

Upon powering on, the instrument will issue a series of status codes as it completes the start up cycle. The pump will start running when the optical bench approaches 55 °C. If starting from room temperature, it will take about 20 minutes before you can connect and another 10 or 15 minutes before it provides accurate measurements. If the instrument is very cold, it will take longer to warm up.

The instrument cannot be powered on from afar. You can restart the instrument through the software interface, but if you power it off through the software interface or the power button, you must press the button or reconnect the main power supply to turn it back on. See *Powering off the instrument* on page 2-11 for additional details.

Power options

The instrument can be powered using the universal AC power adapter, rechargeable batteries, or an external power source using the optional auxiliary power cable. We recommend leaving one battery in the instrument when in use to ensure proper shut down if main power is lost unexpectedly.

Universal power adapter

The universal power adapter is compatible with 100 to 240 VAC power sources, both 50 and 60 Hz. It outputs 24 VDC to power the analyzer and charge the batteries that are installed. The instrument will power on when the universal power adapter is connected to a power source.

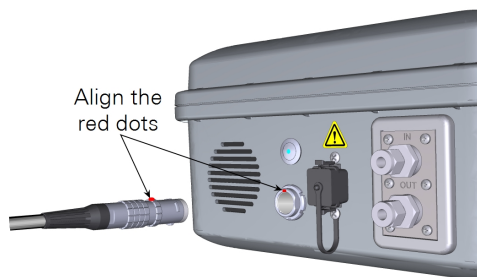

Rechargeable batteries

Two batteries can be installed behind the battery cover. When not using the AC power adapter, a single battery is required to power the instrument. The instrument supports hot-swapping, meaning that you can remove a partially depleted battery and replace it with a charged one and measurements will not be disrupted — as long as the instrument is powered by a charged battery or the AC power adapter.

The batteries are not user serviceable. If a battery exceeds a temperature or load threshold, a non-resettable fuse will open, rendering the battery non-functional. If the batteries become excessively discharged in storage, the charger will supply a 3-minute wake-up charge in an attempt to activate the electronics.

Charging batteries in the instrument

Batteries in the instrument are charged any time the instrument is powered by the universal power adapter. The 10.5 to 33 VDC power terminals (pins 3 and 4; *Table*

Charge Gauge

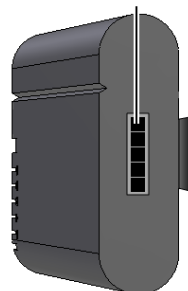

2-1 on page 2-4) do not charge the batteries. The charge status is given in the web interface, the instrument display, and on the battery.

Charging batteries with an external charger

The optional single-bay charger (part number 590-11830; Inspired Energy CH7000A) can charge one battery at a time. To use the charger, plug it into a wall socket and place a battery in the dock. The charger is compatible with 100 to 240 VAC power at 50 to 60 Hz. A blinking LED indicates charging; a solid green LED indicates a full charge.

Note: An optional automobile adapter kit is available to charge the battery from an automobile. Leave the automobile running when charging the battery to prevent excessive discharge of the automobile battery.



Warning: Charge batteries only with a SMBUS compliant level 2 or 3 charger. Do not heat above 80 °C. Do not open battery, dispose of in fire, or short circuit—may ignite, explode, leak, or get hot, causing personal injury. Replace battery with same part number only. Use of another battery may present a risk of fire or explosion. Keep away from children.

Avertissement: Ne rechargez les batteries qu'avec un chargeur conforme au SMBUS niveau 2 ou 3. Ne chauffez pas au-dessus de 80 °C. Ne pas ouvrir la batterie, ni ne la jeter au feu ou court-circuiter—elle peut mettre à feu, exploser, couler, ou s'échauffer, causant des blessures personnelles. Remplacez les batteries seulement avec le même numéro de pièce. L'utilisation d'une autre batterie peut présenter un risque, ou un incendie ou une explosion. A garder hors de portée des enfants.

External power source

You can power the instrument with any 10.5 to 33 VDC power source, such as a deep-cycle marine battery with >20 amp-hour capacity. The external power source should be connected with the auxiliary power cable (optional; part number 9968-242). Attach both red leads to positive (+) and both black leads to negative (-).



Figure 2-1. The auxiliary power cable has bare leads that connect to a power supply.

Table 2-1. Pin assignments for the connector and power cable.

| Pin | Assignment | Color | Description |
|-----|------------|-------|---|
| 1 | Power (+) | n/a | === 24 VDC; 6 Amps from the LI-COR power adapter. These pins, when paired to ground (2 and 6), will power the device and charge the batteries. Not powered through the auxiliary power cable (9968-242). |
| 5 | Power (+) | n/a | |
| 3 | Power (+) | Red | === 10.5 to 33 VDC; Up to 9 Amps. Draws up to 2.3 watts when powered off. These pins, when paired to ground (2 and 6), will power the device but will not charge the batteries. Not powered through the universal power adapter (9968-232). |
| 4 | Power (+) | Red | |
| 2 | Power (-) | Black | Ground |
| 6 | Power (-) | Black | |

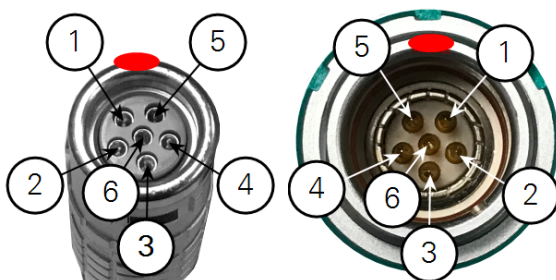

Figure 2-2. Pins for the power cable (left) and instrument power connector (right).

Connecting with the instrument

Connect with the instrument using a web browser on a computer, tablet, or smart phone that is on the same network as the instrument. Windows, macOS, Linux, iOS, and Android OS are supported operating systems. Chrome, Firefox, and Safari are supported browsers, but others may work as well.

Connecting over wireless

Follow these steps to connect to the instrument's wireless network¹.

- 1 Connect your PC or mobile device to the instrument wireless network

When Wi-Fi is enabled the LI-7820 will make a local wireless network, indicated by the presence of a wireless network symbol (📶) on the display. Find the network in the list of networks presented on your device. The *network name* is the *hostname* (and *serial number*) of the instrument. The password is `licorenv`.



- 2 Enter the hostname or IP address in a web browser address bar

One or more of the following will work:

- Hostname: Enter `http://tg20-nnnnn.local` where `tg20-nnnnn` is the hostname (and the serial number) of the instrument.
- Dynamic IP address on the display panel if the network cable is connected.
- Fixed IP address of `http://192.168.10.1` if the internal Wi-Fi is enabled.

- 3 Press **Enter** to connect.

¹This product is capable of creating a Wireless Local Area Network (WLAN). The use of WLAN is restricted in some regions and countries. The illegal use of WLAN may be punishable under these regulations. Check your local regulations to determine if WLAN is permitted. LI-COR, Inc. cannot be held liable for any problems arising from the use of WLAN in any countries or regions. Legal penalties may result from any of the following: enabling Wi-Fi where it is not permitted, modifying or altering the product, or removing the certification labels from the product. To disable the Wi-Fi, see *Enabling and disabling Wi-Fi* on page 2-8.



If you are unable to connect, see troubleshooting *Connection problems* on page 5-1.

Connecting over a wired network

Follow these steps to connect to an instrument that has a wired connection, either directly to your computer or to a local area network.

- 1 Connect a network cable between the instrument and your local network
Install a network cable between the instrument and a vacant network port on your local network or directly to your computer's network port (the instrument and your computer must be on the same network). The instrument will indicate that it is on a network by displaying the network icon () and the network-assigned IP address. If your local network also has Wi-Fi, you can connect to the instrument over the wireless network.

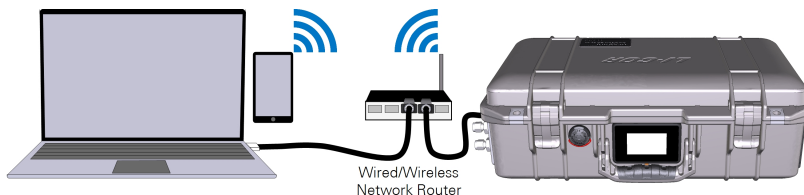

- 2 Enter the hostname or IP address in a web browser address bar
Both the hostname (which is the instrument serial number) and IP address are given on the display. Type one or the other into the address bar:
 - Hostname: Enter `http://tg20-nnnnn.local` where `tg20-nnnnn` is the hostname (and the serial number) of your instrument.
 - Dynamic IP address on the display panel if the network cable is connected.
- 3 Press **Enter** to connect.



If you are unable to connect, see troubleshooting *Connection problems* on page 5-1.

Enabling and disabling Wi-Fi

To alter the Wi-Fi setting, connect to the instrument using a wired network connection (see *Connecting over a wired network* on page 2-6).

- 1 Click **Options > Settings**.
- 2 Click the **Wi-Fi** tab.
- 3 Set Wi-Fi to **Off** or **On**.
- 4 Click **Update** to apply the setting.

If you click away from the page without first clicking **Update**, the setting will not be applied. The Wi-Fi status is displayed in the status bar and the instrument display panel.

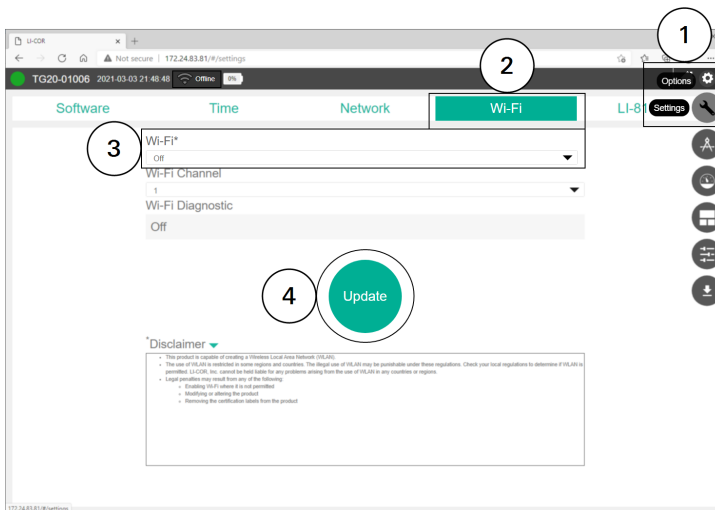

Instrument display

The instrument display panel provides useful information at a glance.

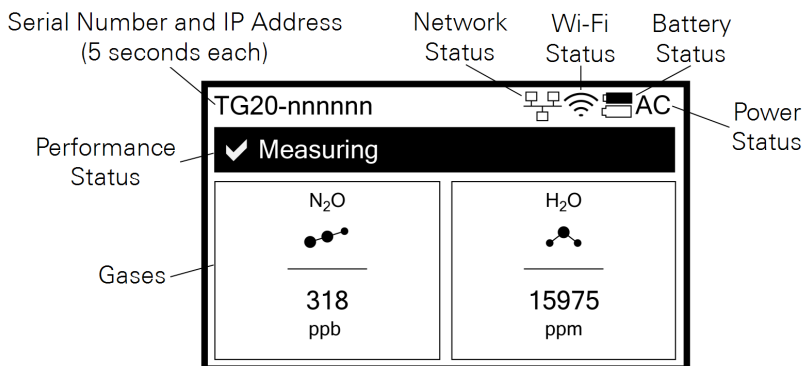























- **Serial Number and IP Address:** The instrument serial number (hostname) and network-assigned IP address (IPv4) rotate for 5 seconds each. The serial number is also printed on the case label. If the network cable is not plugged in, the display will give the IP address for the Wi-Fi network (if enabled).
- **Network Status:** When visible (☐☐☐), the instrument is connected to a network. The network cable is installed between the instrument network port and a port on a local area network.
- **Wi-Fi Status:** When Wi-Fi is enabled (indicated by the 📶 symbol), the instrument broadcasts a Wi-Fi network with the same name as the instrument serial number (and hostname).
- **Battery Status:** Indicates the charge status (). A solid black battery indicates a full charge; an outline indicates a discharged battery. The battery icon is not displayed when no batteries are installed.
- **Power Status:** Indicates the power source (AC if power cable connected).
- **Performance Status:** Indicates performance status of the instrument.
- **Gases:** The gases measured and their concentrations.

Status codes

Status codes are given on the instrument display panel, software interface, and recorded in the data set, where they are associated with measurements.

Table 2-2. Status codes provide information on the status of the instrument.

| Display Indicator | Software Indicator | Status Code | Definition |
|---|--|-------------|--|
|  |  Green | 0 | Normal operation (measuring). |
| |  Yellow | 1 | Start frequency adjustment; Measurements may be noisy. |
|  |  Yellow | 2 | Laser temperature adjustment; Measurements may be noisy. |
|  |  Yellow | 4 | Incomplete scan resulted in missing cavity modes; Measurements may be noisy. |
|  |  Yellow | 8 | Start-up mode finished; Measurements may be noisy. |
|  |  Yellow | 16 | Start-up mode initializing; Measurements may be noisy. |
|  |  Red | 32 | Spectral fit residual RMS too high; Measurements are invalid. |
|  |  Red | 64 | Unregulated pressures or temperatures; Measurements are invalid. |
|  |  Red | 128 | Inlet clogged. Triggered when the inlet is obstructed for 3 or more seconds. When triggered, the instrument turns off the pump and enters sleep mode. Clear the obstructions and restart the instrument. |
|  |  Red | 256 | Instrument not ready; Measurements are invalid. |
|  |  Red | | SVC Required. This message may be issued during warmup. If not resolved after 60 to 90 minutes of operation, contact LI-COR or your sales representative. |
|  |  Red | | SD card error. This message may be issued briefly during warmup or during a firmware update. It should be dismissed quickly. If not, contact LI-COR or your sales representative. |

Status codes are additive: if multiple codes are active, the displayed value is the sum of the codes. For example, a display code of 23 indicates that the instrument is initializing the start-up mode (16), it has an incomplete scan (4), laser temperature adjustment is underway (2), and a start frequency adjustment is underway (1). Non-zero status codes are displayed during warmup and any time the instrument is not in a normal state. Typically, status codes will be resolved by the instrument. Occasionally, you may need to restart the instrument to resolve the code. If your instrument displays a status code that does not resolve itself for several hours or after restarting the instrument, contact technical support.

Powering off the instrument

The instrument can be powered off with the power button or through the software interface. To **Power Off** the instrument with the button, press it three times within 5 seconds. To enter **Sleep Mode**, press the power button twice within 3 seconds. In sleep mode, the instrument will power off the pump but maintain power to the heaters. Sleep mode is to silence the pumps, if, for example, you want to hear the birds singing while you walk between measurements. To **Exit Sleep Mode**, press the power button after waiting at least 5 seconds after the previous press.

Caution: While in sleep mode, the instrument will stop drawing in air, which may affect the pressure and flow in your air supply system. Do not enter sleep mode when the air inlet or outlet is subject to positive or negative pressure. Pressures exceeding 110 kPa absolute pressure may damage the instrument.

If a battery becomes depleted during normal operation, the instrument will complete the dry-down cycle before shutting itself down. If the instrument is inadvertently powered off and prevented from completing the dry-down cycle (by removing the batteries and power cable, for example), power it back on and off again so it can complete the dry-down cycle.

Caution: Failure to complete the dry-down while powering off the instrument may result in condensation in the optics, which may damage the instrument and require repairs.

Storing the instrument

The instrument can be placed in short-term storage (for several weeks) without any special preparations. For longer-term storage (longer than a month), we recommend that you remove the batteries from the case and clean and dry the instrument exterior with a soft damp (not dripping) cloth and mild detergent if needed. The battery storage temperature range is -20 to 60 °C, <80% relative humidity. The instrument storage temperature is -45 to 50 °C, <85% relative humidity.

Shipping the instrument

The instrument is delivered with custom-designed foam pad (part number 6578-296) that protects the air inlet and outlet while it is packaged. Keep the foam pad so you can use it to ship the instrument, should the need arise. Cover the air inlet and outlet with the blue caps that were provided with the instrument or scotch tape to keep dust from the filter. Position the foam pad over the inlet and outlet, wrap the instrument with plastic wrap, place it in a large plastic bag, and then tape it tightly so that the foam will stay in place. Place the wrapped instrument in a box with foam packing peanuts.

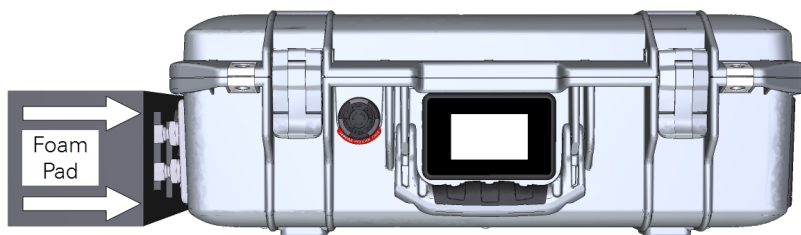

Figure 2-3. The foam pad protects the inlet, outlet, and network cable connector during shipping. Keep the pad in the event that you need to ship the instrument.

Important note on shipping lithium ion batteries

Many new LI-COR instruments are powered by lithium ion batteries; LI-COR recommends that you **do not** ship these batteries, unless you need them examined. Effective April 1, 2016, new shipping requirements were issued regarding the shipment of lithium ion batteries. There are three separate shipping scenarios described below: 1) Batteries are packaged with the original equipment, 2) Additional batteries

(quantity of two or fewer) are packaged without the original equipment, and 3) Additional batteries(quantity of three to ten) are packaged without the original equipment.

Shipping batteries with equipment

When packed **with** equipment, lithium ion batteries (quantity 1-3) are classified as UN3481, packing instruction 966, section II, and require that the package be labeled with the Lithium Ion battery handling label (see *Figure 2-4* on the next page). A full-size copy of this label that can be printed and affixed to the package can be downloaded from <https://licor.box.com/v/Li-Ion-Shipping-Label>.

Shipping batteries without equipment (2 or less)

When packed **without** equipment, lithium ion batteries (quantity 1-2) are classified as UN3480, packing instruction 965, section II, and require:

- Not declared as Dangerous Goods.
- One or two batteries.
- Shipper's Declaration: Quantity and type of packing - Packing: **1 Fiberboard Box**, Quantity: **0.46 kg** weight per battery.
- Label package with Lithium Ion battery handling label.
- Label package as Cargo Aircraft only.
- Airway bill states "Lithium ion batteries in compliance with Section II of PI 965".
- Only one package per consignment.

Shipping batteries without equipment (3 to 10)

When packed **without** equipment, lithium ion batteries (quantity 3-10) are classified as UN3480, packing instruction 965, section IB, and require:

- Is declared as Dangerous Goods (Proper shipping name: UN3480 Lithium Ion Batteries, Class 9)
- Three to ten batteries
- Shipper's Declaration: Quantity and type of packing - Packing: **1 Fiberboard Box**, Quantity: **0.46 kg** weight per battery

- Label package with Lithium Ion battery handling label; a copy of which can be printed and affixed to the package by downloading from <https://licor.box.com/v/Li-Ion-Shipping-Label>.
- Label package as Cargo Aircraft only
- Label package with Class 9 hazard label
- Airway bill states “Lithium ion batteries in compliance with Section IB of PI 965”

Notes

- These packages must be handled with care. A flammability hazard exists if the package(s) is damaged.
- If package is damaged in transport, it must not be loaded until the condition of the contents can be verified. The batteries contained in the package must be inspected for damage and may only be repacked if they are intact and protected against short circuits.



Figure 2-4. Example of Lithium Ion battery handling label. You can download a full-size copy from <https://licor.box.com/v/Li-Ion-Shipping-Label>.

Section 3.

Applications of the LI-7820

In this chapter we provide information about using the instrument in field or laboratory applications. We cover connecting plumbing to the air inlet, retrieving data, and other applications.

Flow schematic

During normal operation, air is drawn into the analyzer through the air inlet (above). Air flows through the optical bench and phase adjuster and is exhausted through the air outlet. In the optical bench, the pressure is drawn down to about 40 kPa. When the instrument is powering down, air is circulated in a closed loop through the desiccant to ensure that air remaining in the system is free of moisture, preventing condensation when the instrument is powered off.

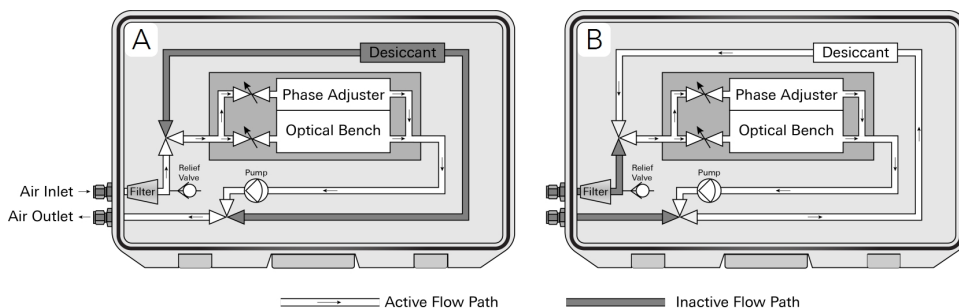

Figure 3-1. Simplified flow schematic of the gas analyzer. During a measurement, (A) air flows through the optical bench and phase adjuster. During shutdown (B), the instrument purges the optical path of water vapor.

Soil gas flux measurements

The LI-7820 works well for soil gas flux measurements when coupled with the LI-8250 Multiplexer and the Smart Chamber. All hardware, cables, and tubing required for the connection is available for purchase. The digital communication connection is established through the LI-8250 or Smart Chamber web interface. Full details are provided in the LI-8250 and Smart Chamber instruction manuals.

Connecting the air inlet and outlet

Air is drawn into the sample cell through the air inlet. Connect a ¼" outside diameter metal or plastic tube to the air inlet compression fitting. The nut and ferrule sets are in the accessories kit.

Caution: Be very careful when working near standing water. If water is drawn into the air inlet, the instrument will have to be repaired at the factory.

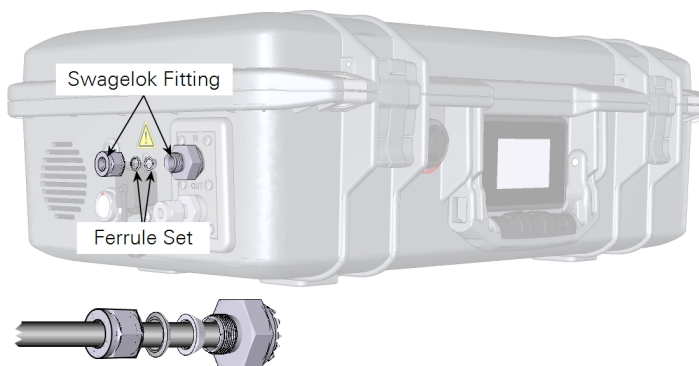

Figure 3-2. When connecting a tube to the air inlet, use steel ferrules to form a good seal.

Tighten the nut over the ferrule set until it is finger tight. For metal and plastic tubing, tighten it an additional 1¼ turns if you are connecting the tube for the first time. For plastic tube that is highly pliable, insert a stainless steel tube insert (300-18126) to make the end of the tube rigid. When reconnecting a plastic or metal tube that has been connected previously, simply tighten it ¼ turn beyond finger tight. Tubing can be connected to the outlet in the same way.

Important: Abrupt pressure transients up to 35 kPa above or below ambient pressure may cause momentary status warnings, inlet plugged warnings, and measurement inaccuracies. Longer lasting pressure excursions or larger pressure transients may cause the instrument to reinitialize measurement control loops.

Plumbing a subsample

Note: We are currently refining numerous sampling protocols for the LI-7820. Contact LI-COR technical support (envsupport@licor.com) if you have questions about your application.

A typical sampling application will use the LI-7820 to subsample a gas from a main sample line. Air passes a single time through the gas analyzer before it is discharged. Air supplied to the sample inlet should be between ambient and 35 kPa (5 PSI) above ambient. If the pressure is higher than that, install a 30 cm vent in the sample line to ensure that air from the external pump does not pressurize the analyzer. The vent must be sufficiently long to prevent diffusion of ambient air into the sample air supply.

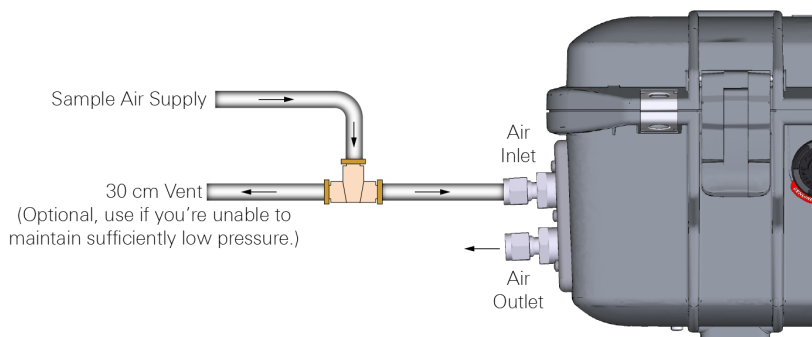

Figure 3-3. A basic open system, where air is supplied to the gas analyzer by an external pump. If the pressure exceeds 35 kPa above ambient, install a 30 cm vent in the air supply line. Attach the inlet to the 'leg' of the T-fitting to avoid isotopic fractioning.

Configuration options

The instrument supports three operating configurations, including standard, reduced flow rate, and high altitude.

Standard

The standard configuration is the default - it will be loaded automatically unless the configuration has been changed under **Options > Settings > Software > Configuration**.

Reduced flow rate

The reduced flow rate adapter (part number 7800-112) is an accessory for the analyzer that, when installed, enables the analyzer to operate at a nominal flow rate of 70 sccm, rather than the standard nominal flow rate of 250 sccm.

By installing the kit you will modify the internal flow routing of the instrument. When the kit is installed, you must use the **Reduced Flow Rate** configuration in the software. The reduced flow rate is not compatible with closed-loop applications because the inlet and outlet flow rate are different.

Caution: Refrain from installing and removing the kit repeatedly because the tubing is not designed for repeated assembly and disassembly.

The kit is supported by instrument software version 2.0.25 and newer, which is available from the LI-COR support website (licor.com/env/support).

Installing the kit

Power off the instrument before installing the kit.

- 1 Identify the tube that connects the pump to the optical bench. Pay careful attention to the orientation of the T-fitting. In early models, this tube comes off of the stem of the T. In later models, it comes off of the cross of the T. In either case, cut the tube with a clipper where indicated.

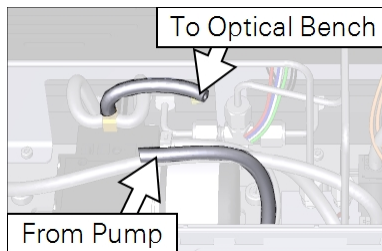
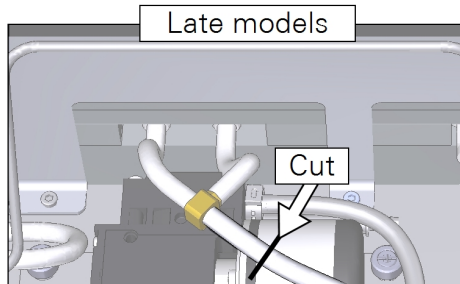
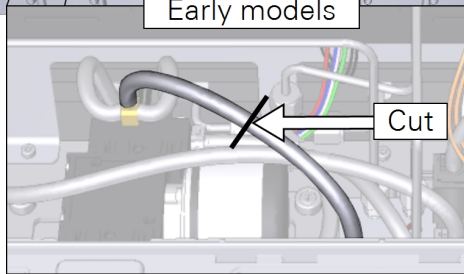
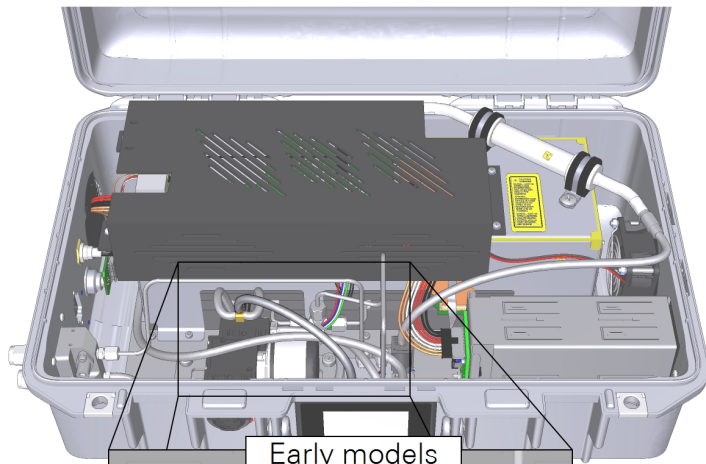

- 2** Gather the kit and components.

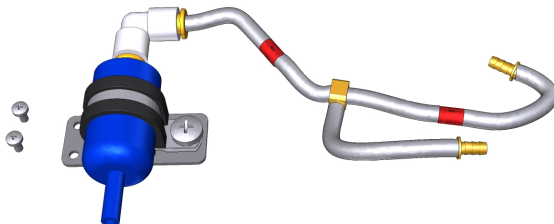

- 3** Secure the filter and tube assembly in the analyzer case with the two panhead screws.

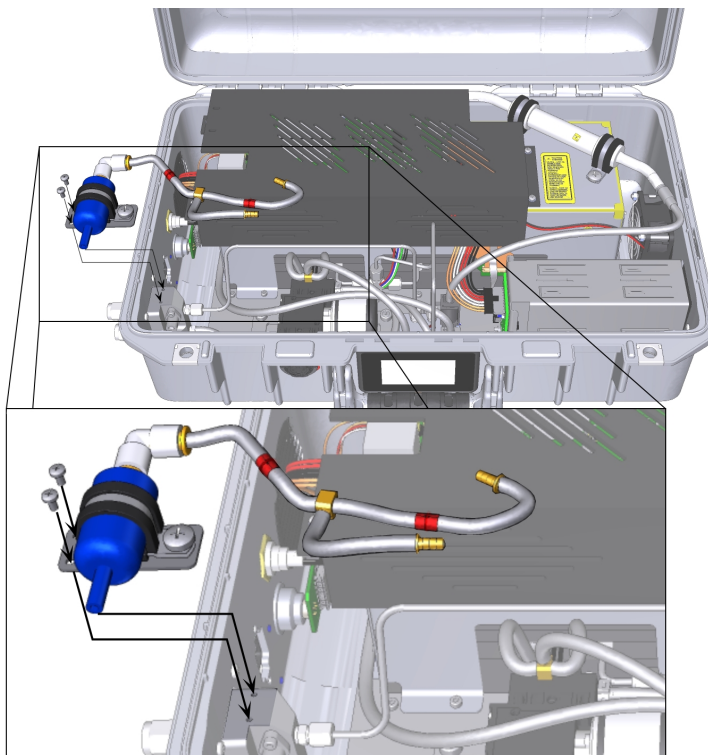

The tubes will be straight before installation but they will easily bend to fit. They should go under the stainless steel tube air intake tube. Be careful to avoid jostling or moving the stainless steel tubes; moving them can cause leaks.

- 4 For both tubes, press the hosebarb coupler into the cut tube, as shown.

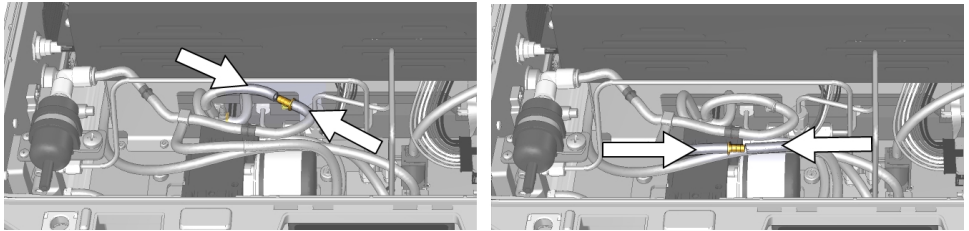

The completed assembly is shown below.

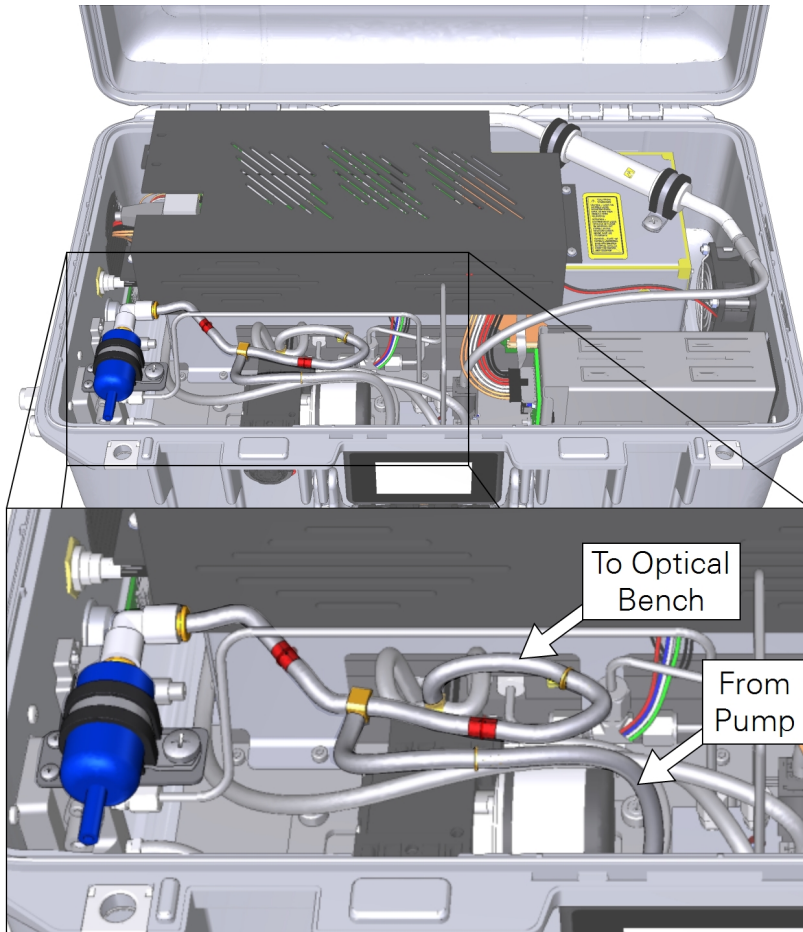

Configuring the software for the reduced flow kit

Power on the instrument, let it warm up, and connect to it using a computer or mobile device. The instrument will start in the standard operating mode. Starting up in the standard mode while the **Reduced Flow Rate Kit** is installed will trigger warnings and errors; ignore them for now.

- 1 Navigate to **Options > Settings > Software > Configuration** and select **Reduced Flow Rate**.

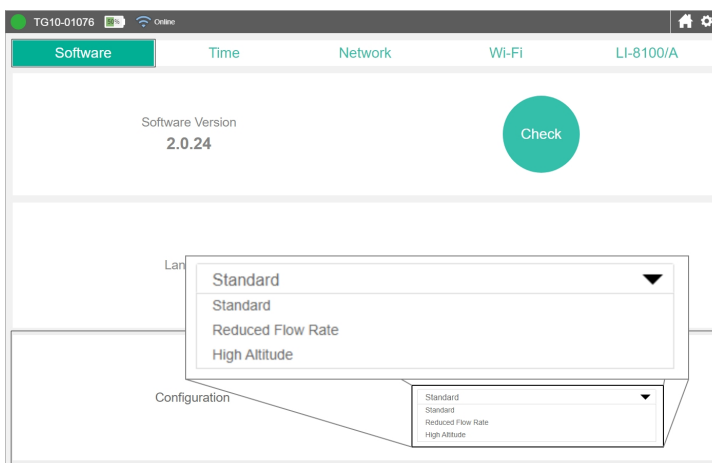

- 2 When prompted, click **Yes, I'm sure** to proceed.

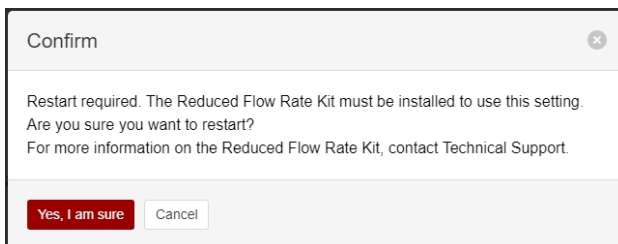

The instrument will restart and initialize with the reduced flow rate configuration.

If you want to restore the normal flow rate, you must remove the reduced flow rate kit, change the software configuration to **Standard**, and restart the instrument.

Caution: Refrain from installing and removing the kit repeatedly because the tubing is not designed for repeated assembly and disassembly.

High altitude

The high altitude configuration does not require any hardware modifications. The reduced flow rate hardware modifications cannot be used while the instrument is in the high altitude configuration; if the kit has been installed, remove it before using the high altitude configuration. To use the high altitude configuration, select it under **Options > Settings > Software > Configuration** and restart the instrument. Be aware of slight differences in the performance specifications of the instrument while in the high altitude configuration.

See *Specifications* on page C-1 for details.

Retrieving data from the instrument

The instrument records all of its data after it has warmed up. There is no way to turn data logging on or off because data are always logged. Typically, the instrument can store a total of 5,356,800 records, which is about 62 days of continuous data. Old records are overwritten when the memory is full. Therefore, we recommend that you routinely download important data from the instrument. When used with the Smart Chamber or LI-8250 Multiplexer, measured values are transferred automatically to the Smart Chamber or LI-8250.

The instrument also supports two protocols for transferring data:

- Direct download using TCP/IP (internet protocols; see *Downloading a data file* below) and
- MQTT (Message Queuing Telemetry Transport; see *Communication with the MQTT protocol* on page 7-1).

Downloading a data file

To retrieve data from the instrument, click **Options > Export**. Specify a date range and time period. Dates are displayed as YYYY-MM-DD. Time options are given in a 24-hour clock (00:00 through 24:00). Click **Export**. The web browser will prompt you to save or open the file, and then provide a text file with the requested data. The file has a `.data` extension. Measurements are recorded as tab-delimited text that can be opened in a text editor or spreadsheet application.

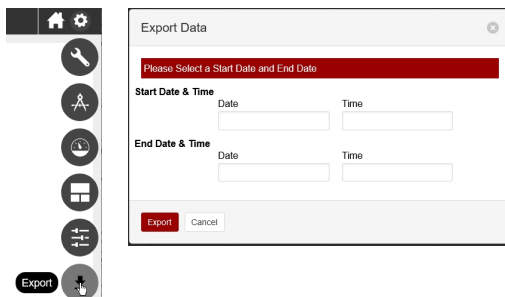

*Figure 3-4. To download data, click **Export** from the settings menu, select a date and time range, and click **Export**.*

Components of the data file

The text file will include a file header, data header, and data.

File header

The file header provides information about the instrument that measured the data.

| Header Label | Description |
|------------------|--|
| Model | The model of the instrument |
| SN | The serial number of the instrument |
| Software Version | The software version on the instrument |
| Timestamp | The date and time of the beginning of the requested data (according to the instrument clock; yyyy-mm-dd hh:mm:ss). |
| Timezone | The timezone setting on the instrument when the data is requested. |

Data header

The data header identifies the columns of values that are in the file. You'll see two rows: one called DATAH, which gives the variable names for the corresponding columns, and one called DATAU, which gives the units for the corresponding columns.

| DATAH | DATAU | Description |
|---------------|-------|--|
| SECONDS | secs | Seconds past the universal epoch (Unix time). |
| NANOSECONDS | nsecs | Nanoseconds of the seconds |
| NDX | index | A count of scans. At four scans per second, the value increases by four counts per second. |
| DIAG | diag | Diagnostic code (see <i>Status codes</i> on page 2-10) |
| REMARK | - | The remark entered in the Remark field |
| DATE | date | Date of the record in yyyy-mm-dd |
| TIME | time | Time of the record in HH:MM:SS (according to the instrument clock) |
| H2O | ppm | Water vapor concentration |
| N2O | ppb | N ₂ O mole fraction in dry air |
| CAVITY_P | kPa | Optical cavity pressure (typically near 39) |
| CAVITY_T | °C | Optical cavity temperature (typically near 55) |
| LASER_PHASE_P | kPa | Laser phase pressure |
| LASER_T | °C | Laser temperature |
| RESIDUAL | n/a | Difference between raw and best fit spectra |

| DATAH | DATAU | Description |
|---------------------|--------|---|
| RING_DOWN_TIME | µsecs | Indicator of cavity resonance |
| THERMAL_ENCLOSURE_T | °C | Optical enclosure temperature |
| PHASE_ERROR | counts | Dimensionless indicator of mode lock state |
| LASER_T_SHIFT | °C | Shift in laser center wavelength from factory calibration |
| INPUT_VOLTAGE | V | Power supply voltage |
| CHK | CHK | Checksum; to ensure that the receiving software received the data without error, and to reject corrupted data lines |

Time, data , and diagnostics

The time, data, diagnostics, and remark are given under the header.

```

1 Model: LI-7820
2 SN: TG20-01002
3 Software Version: 2.1.5
4 Timestamp: 2020-11-18 10:00:00
5 Timezone: America/Chicago
6 DATAH SECONDS NANOSECONDS NDX DIAG REMARK DATE TIME H2O N2O CAVITY_P CAVITY_T LASER_PHASE_P
7 DATAU secs nsecs index diag date time ppm ppb kPa °C kPa °C µsecs °C counts °C
8 DATA 1605715200 9968996 5169489 0 "" 2020-11-18 10:00:00 7779.4116 316.70258 40.6372 55.0003 28
9 DATA 1605715201 9968996 5169499 0 "" 2020-11-18 10:00:01 7775.4009 315.13116 40.6362 55.0003 28
10 DATA 1605715202 9968996 5169509 0 "" 2020-11-18 10:00:02 7768.2007 315.23959 40.6362 55.0003 28
11 DATA 1605715203 9970188 5169519 0 "" 2020-11-18 10:00:03 7772.7192 316.14041 40.6369 55.0003 2C
12 DATA 1605715204 9970188 5169529 0 "" 2020-11-18 10:00:04 7779.3667 315.58978 40.6374 55.0003 2P
13 DATA 1605715205 9970188 5169539 0 "" 2020-11-18 10:00:05 7783.5815 315.40985 40.6369 55.0003 2b
14 DATA 1605715206 9974956 5169549 0 "" 2020-11-18 10:00:06 7782.5288 315.12115 40.6365 55.0003 2C
15 DATA 1605715207 9974956 5169559 0 "" 2020-11-18 10:00:07 7781.0869 315.23413 40.6359 55.0003 2P
16 DATA 1605715208 9974956 5169569 0 "" 2020-11-18 10:00:08 7779.187 315.65839 40.6367 55.0003 2b
17 DATA 1605715209 9974002 5169579 0 "" 2020-11-18 10:00:09 7775.0786 316.18747 40.6362 55.0003 2E
18 DATA 1605715210 9974002 5169589 0 "" 2020-11-18 10:00:10 7766.0029 316.78662 40.6364 55.0003 2E
19 DATA 1605715211 9974002 5169599 0 "" 2020-11-18 10:00:11 7769.5625 316.84085 40.637 55.0003 2b

```

The relationship between Unix Epoch time and the time stamp

The instrument measures time based upon the number of seconds past the Unix epoch (GMT: Thursday, January 1, 1970 12:00:00 AM). This value is represented in the **Seconds** column of the data set. You can easily convert the Unix epoch to date and time using online resources (e.g., <https://www.epochconverter.com>). If you have selected a time zone, the Date and Time columns will represent the Unix epoch time adjusted by an offset for the time zone.

Installing the instrument in a rack mount

The LI-7820 can be mounted in an instrument rack with a stationary or sliding shelf with dimensions of at least 33 cm by 61 cm (13" by 24") with 18 cm (7") of vertical clearance. The instrument dimensions are given in *Figure C-1* on page C-3. Be sure that the vents on the sides are not obstructed. Allow 2 to 3 cm (~1 inch) of clearance on either side of the vents. Ensure that air can flow freely around the case.

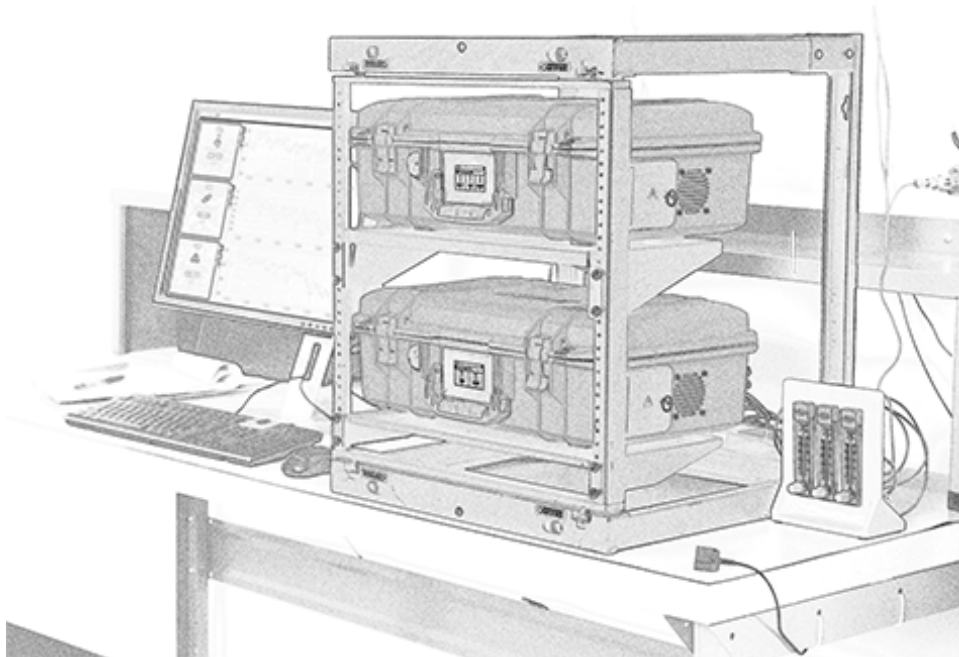

Section 4.

Software overview

The web interface provides access to the most important settings in the gas analyzer. Here, you can view graphs of data, download recorded data, configure the display, and alter instrument settings.

Home page

When you first connect to the instrument, it will display a home page with measurements, graphs, and options.

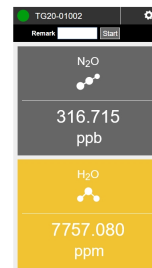
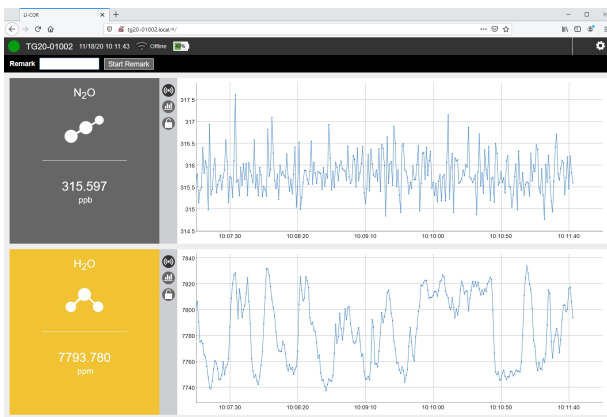

Indicators and buttons

You'll see the instrument serial number and status in the upper left. Normal operation is indicated by a green dot. A warmup or other status is indicated by an exclamation point in a yellow or red dot beside the instrument name.



Status indicator displays the performance status of the instrument. Green indicates normal operation. Red with an exclamation point indicates that the instrument is warming up or in an error state (see *Performance status indicators* on page 4-11).



Battery charge status. The value (%) is the total charge available. Two fully charged batteries = 100. (50 can mean one fully charged battery or two half charged batteries). Check the charge gauge on each battery or the instrument display to determine which is depleted.



Wi-Fi and network status information (see *Wi-Fi* on page 4-8).



Click to view the **Options** menu.



Click to return to the home page (only visible when not on the home page).

Remarks

Remarks are user-entered information (15 characters maximum) that is recorded in the dataset along with other data in the database, including gas densities and diagnostics. For example, you might enter some information about the current measurement or data that you want to associate with the measurement in the records.

| | | |
|---------------|----------------------|---------------------|
| Remark | <input type="text"/> | Start Remark |
|---------------|----------------------|---------------------|

To enter a remark, simply type it into the field and click **Start Remark**. The remark will be recorded with each data record until you click **End Remark**.

Graphs

In the graphs, you can click and drag to **zoom in** and **reset the zoom** by double-clicking the graph. For any gas, you can click the rectangular panel to view more details, including the current measurement, mean, standard deviation, and slope for the displayed time range. You can adjust the plotted time range with a slider or by typing in the number of seconds in **Graph Range (Seconds)**. Click **Reset** to restore the default range of 300 seconds.

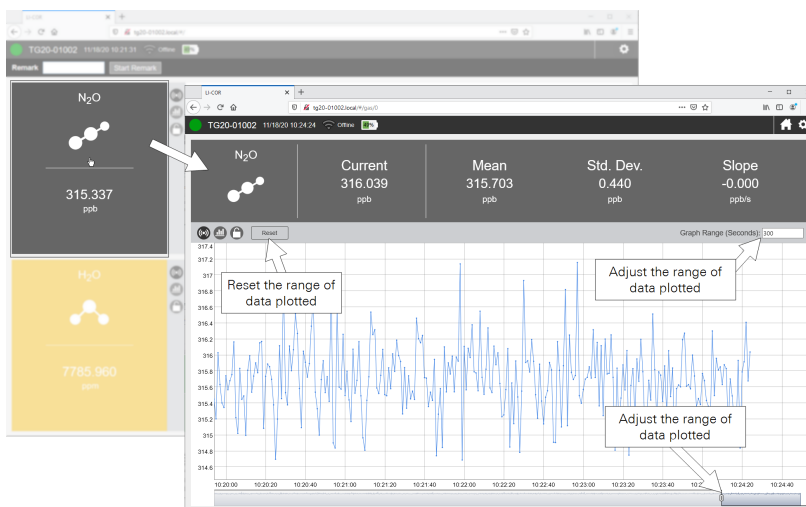

Click to display the entire history of measurements of this variable.



Click to hide or show anomaly stripes (to indicate when a measured value exceeds a threshold (see *Thresholds* on page 4-15).



Click to lock the graph to the current view. Click again to restore live graphing.

Settings

Click **Options** > **Settings** to view a menu with basic instrument settings, including software updates and language, instrument configuration, time, networking, Wi-Fi, and connection to peripheral instruments.

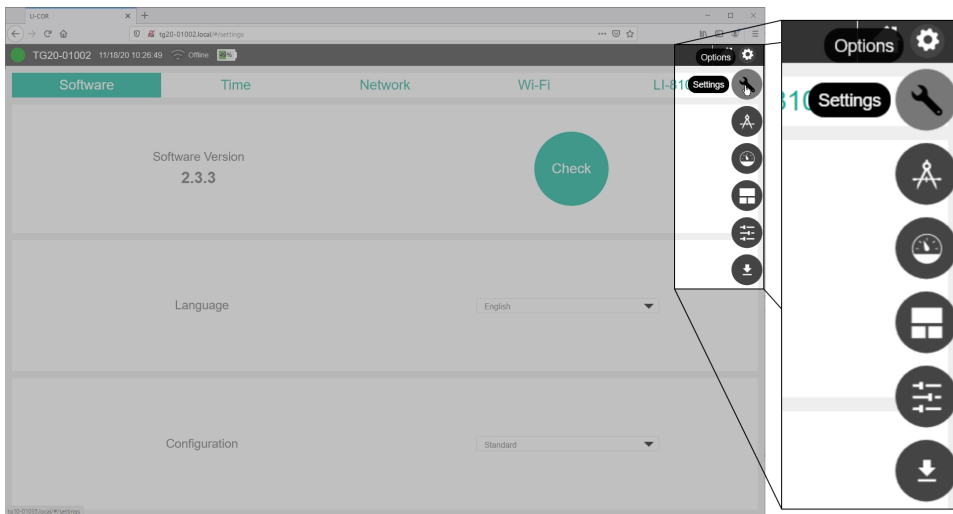

Software

Click **Options** > **Settings** to view a menu with basic instrument settings, including software updates and language, instrument configuration, time, networking, Wi-Fi, and connection to peripheral instruments.

The instrument must be online to check. See *Software updates* on page 6-7 for update instructions.

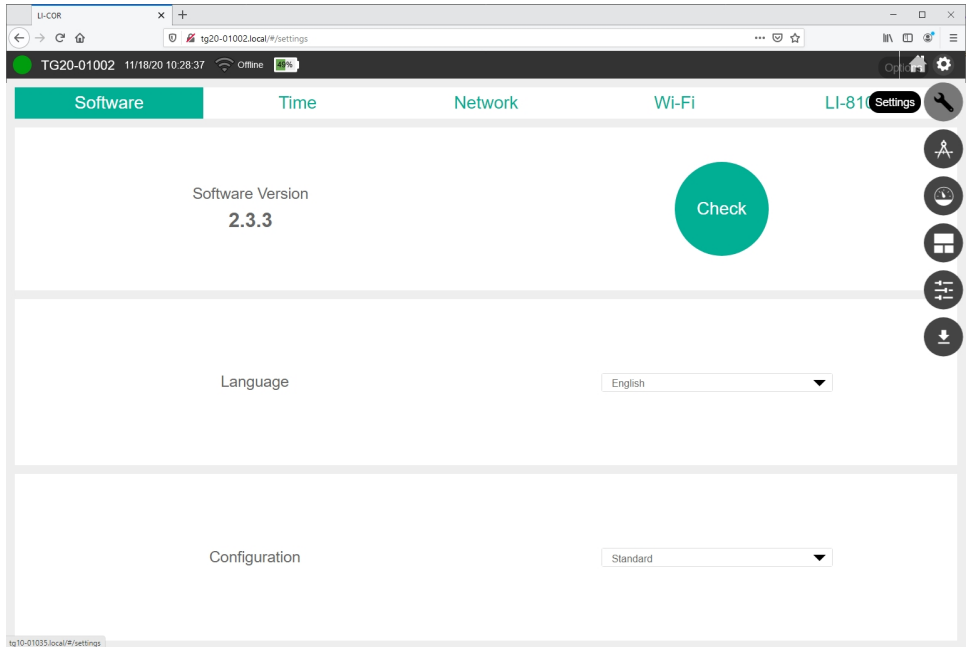

The **Language** setting is configured under software settings. The interface can be displayed in English, Spanish, and simplified Chinese languages. The language setting is retained in the web browser, not the instrument. If you connect with a different browser or different computer, or if you clear your browser cache, the default language setting will be applied (English).

The **Configuration** option provides three instrument configurations, described below. Note that the instrument must be restarted after changing the configuration.

- **Standard:** Nominal flow rate of 250 sccm; Operating pressure range of 70 to 100 kPa.
- **Reduced Flow Rate:** Nominal flow rate of 70 sccm; Operating pressure range of 70 to 110 kPa. A hardware kit must be installed to use the reduced flow rate setting. See *Reduced flow rate* on page 3-4.
- **High Altitude:** Nominal flow rate of 150 sccm; Operating pressure range of 50 to 110 kPa. See *High altitude* on page 3-9.

Time

Under **Settings > Time**, you'll find two subtabs related to the time settings: **Instrument Time** and **Time Zone**.

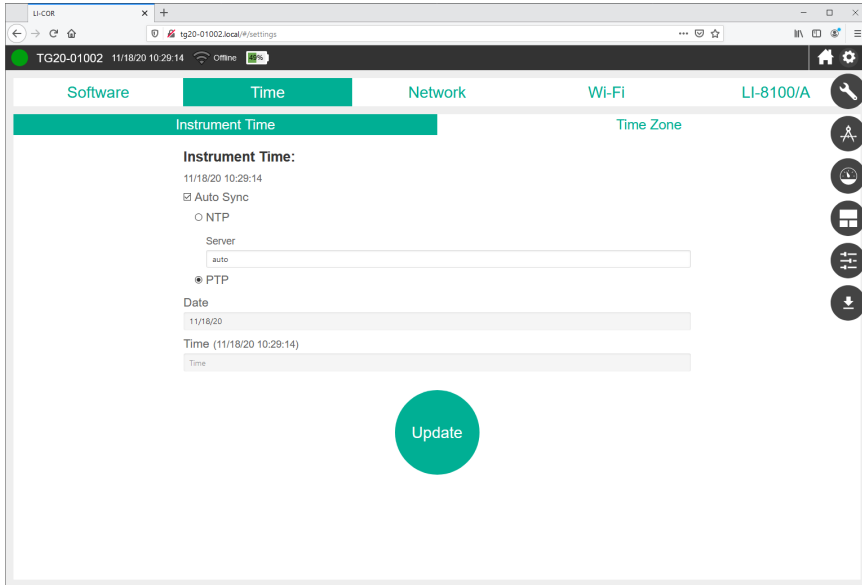

Instrument time

These settings specify how the device should set its time. See *The relationship between Unix Epoch time and the time stamp* on page 3-12 for more details.

Auto Sync: We recommend using this setting at all times to prevent clock drift. When selected, the instrument will set its clock according to the local network time. When not selected, you must enter the desired time manually. The Auto Sync options are:

- **NTP:** Network Time Protocol. A time protocol designed for low-cost time synchronization between computers and devices. You can use the default settings of `auto` or select an NTP server, either from your network or the internet. A list of NIST time servers is available from <https://tf.nist.gov/tf-cgi/servers.cgi>.
- **PTP:** Precision Time Protocol. A network time protocol designed for high accuracy (microsecond to nanosecond) time synchronization between clocks.

Date: If Auto Sync is cleared, you can enter a date manually.

Time: If Auto Sync is cleared, you can enter the time manually.

When the instrument time setting is set to **Auto Sync** and the instrument is connected to the internet, it will maintain very accurate time, in sync with NTP or PTP clocks. If Auto Sync is disabled, or the instrument is not online, expect the clock to drift up to several seconds per month, or more.

Time zone

Here you can select a time zone that applies an offset to the Unix epoch time. If you change any of the time settings, click **Update** to apply the changes.

Network

Under **Settings > Network**, you configure the network settings. If you change the settings, click **Update** to apply them.

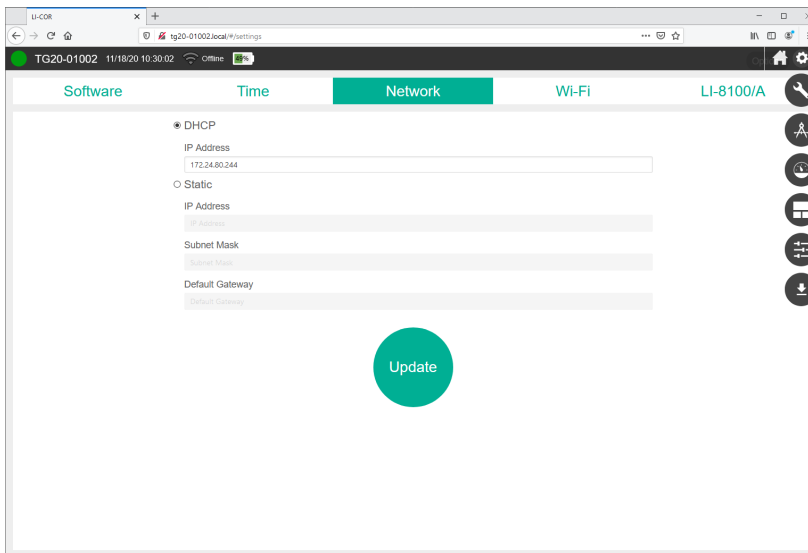

DHCP: Dynamic Host Configuration Protocol; This setting is suitable for most networks. When selected, the network assigns an IP address to the instrument.

- **IP Address:** The assigned IP address is displayed here (and on the instrument display).

Static: Used to set a static IP address. This setting is used when configuring the instrument to communicate over a cellular gateway, such as the Sierra Wireless RV-

50X AirLink. When selected, you manage the networking manually by setting the IP address, subnet mask, and possibly the gateway.

- **IP Address:** Enter the desired IP address. For a local network, you will use something like 172.24.1.nn, where the values represented by nn are octets that uniquely identify this instrument on the network.
- **Subnet Mask:** Typically 255.255.255.0.
- **Default Gateway:** Set the first two octets to match those of the IP address.

Wi-Fi

Under **Settings > Wi-Fi** you can configure the wireless network settings, including whether the wireless network is on or off, and which channel it uses. You can always use the default setting, but if there are many devices using that channel, you may have better results with a channel that has fewer devices. If you have difficulty connecting, try changing the channel that the instrument uses.

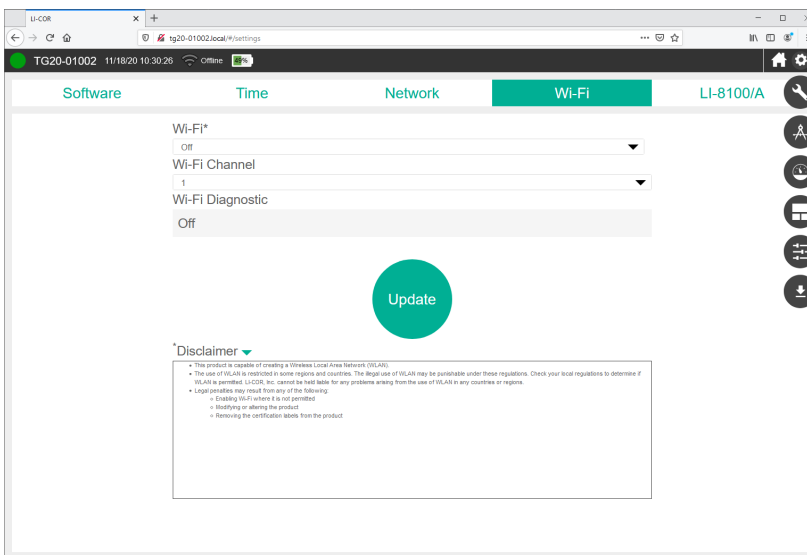

When Wi-Fi is on, the instrument will create a local network that is not connected to the global internet. You should see the network on the list of available networks. The network name is the same as the instrument serial number. If you change the settings, click **Update** to apply them. You can also choose a channel for communication over the wireless network. When there are many Wi-Fi networks avail-

able in one location, you can assign a specific channel for a more reliable connection.

LI-8100/A

Under **Settings > LI-8100/A** you configure communication with the LI-8100/A instrument.

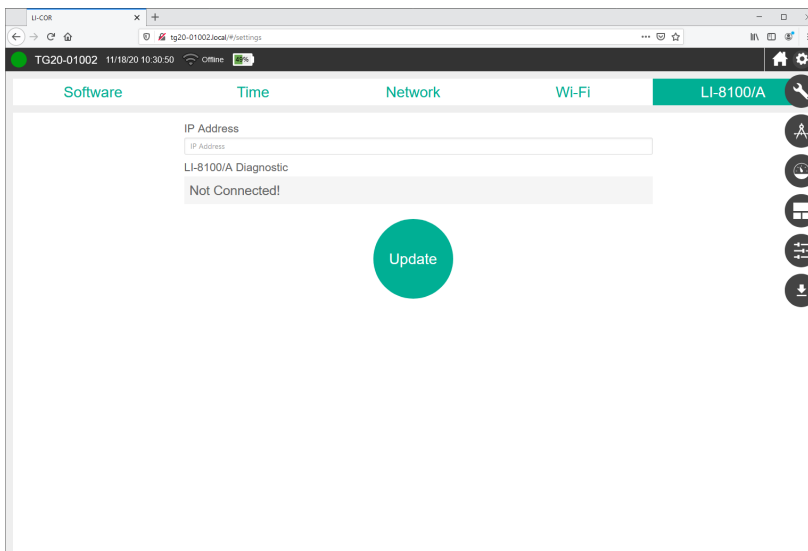

IP Address: To connect with an LI-8100A, enter the LI-8100A IP Address here. Additional details are provided in an application note:

<https://www.licor.com/env/support/LI-8100A/topics/LI-78xx-integration.html>

Calibration

User calibration settings are configured under **Options > Calibration**.

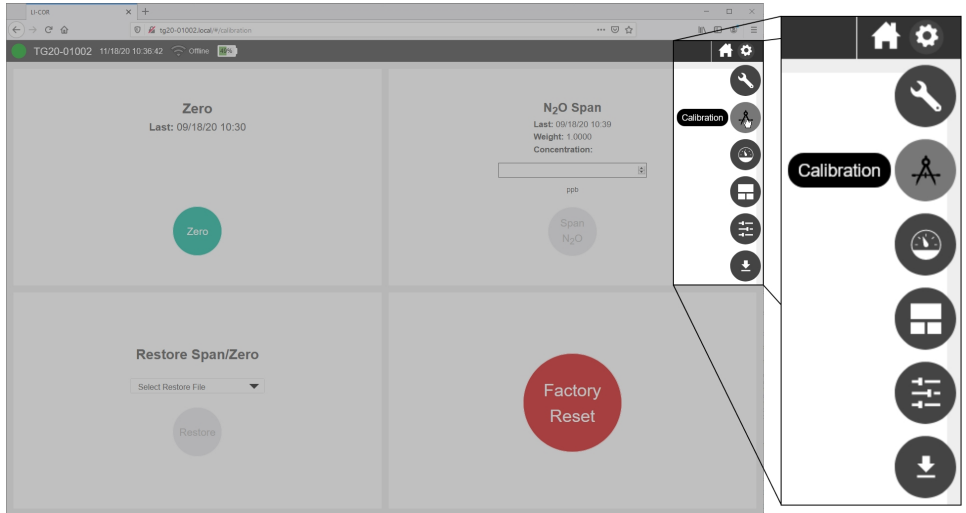

Zero gives the date of the most recent zero calibration. See *Instrument calibration* on page 6-1 for details on the Zero button.

N₂O Span presents information about the previous span setting, including the date that the span was set (**Last**), the span value (**Weight**; the multiplier that is set when you span the N₂O measurement), and the N₂O **Concentration** (ppb) entered in the previous span. Do not change the settings unless you are certain that your actions will improve the performance of the instrument. See *Instrument calibration* on page 6-1.

Restore Span/Zero allows you select a previous zero and span setting.

Factory Reset reloads the factory original zero and span calibration parameters.

Diagnostics

The **Diagnostics** section provides instrument performance information, including the status, warnings, and diagnostic information.

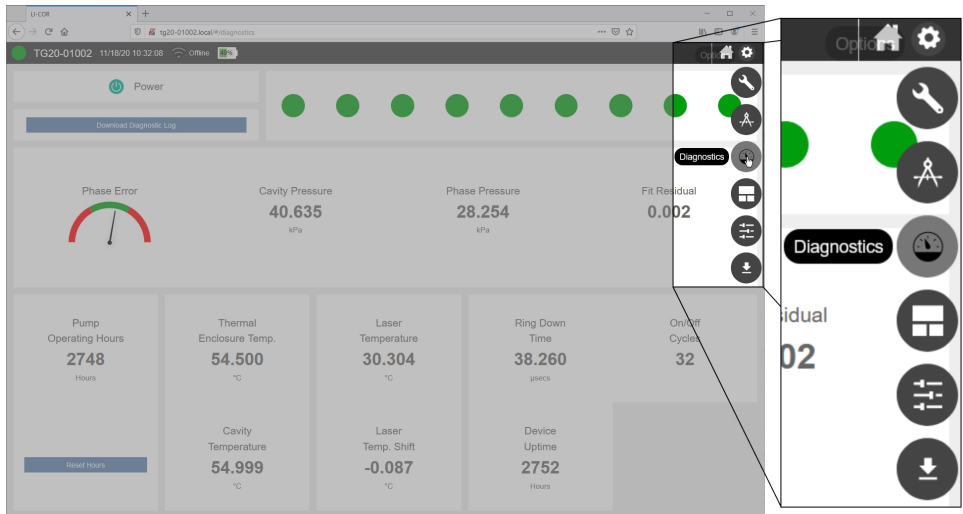

Power



In the upper left, the **Power** option allows you to power off or restart the instrument. The instrument cannot be powered on remotely.

Performance status indicators

In the upper right, nine bubbles provide more detailed status information. Normal operation is indicated by green bubbles. An exclamation point inside one or more bubbles indicates that the instrument is not in a normal operating state. Typically these are displayed when the instrument is warming up, and the status message will disappear when the warmup is completed. Click a bubble to view the status message. See *Status codes* on page 2-10 for more information. If your instrument is displaying warnings that do not resolve themselves over the course of a few hours or by restarting, contact technical support.

Diagnostic log

Download Diagnostic Log is to download a dataset that includes detailed performance information. This option should be used in consultation with LI-COR technical support in order to resolve performance issues. Diagnostic log files can be very large, (hundreds of MB, depending on the time and date range), so we recommend that you constrain the dates to a narrow time window when downloading a diagnostic log.

Performance monitor

The central portion of the window provides more details about the instrument performance.

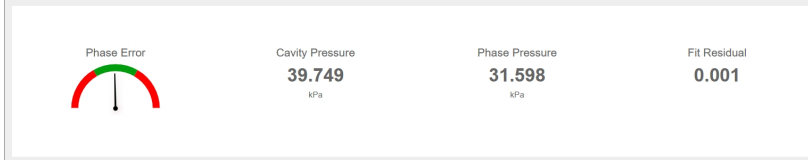

- **Phase Error** is an indicator of the symmetry of cavity modes. During normal operation the needle will be within the green part of the dial.
- **Cavity Pressure** is measured in the optical cavity. The instrument operates around 40 kPa typically. If the values are colored red, that indicates that the instrument is unable to regulate the cavity pressure. Normally this value is within 1 kPa of the setpoint.
- **Phase Pressure** refers to the pressure for the phase adjuster volume. If red, the instrument is unable to regulate the pressure to get optimal phase adjustment. Normally this value is within 1 kPa of phase pressure setpoint.
- **Fit Residual** is the difference between the raw spectra and the best fit spectra which generates the measured concentrations. If the residual is red, it indicates that the instrument is unable to process the data properly and that the concentrations are not being reported accurately. Data will be flagged in this case.

Operating information

The bottom portion of the window provides more details about the instrument operating history and status.

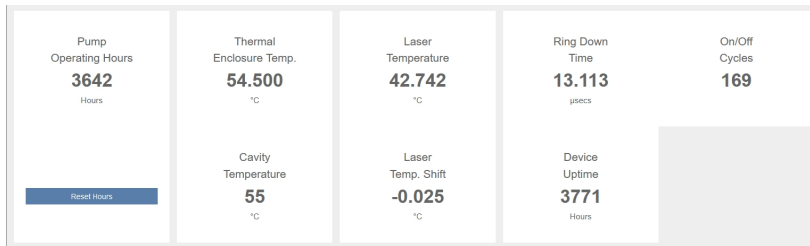

- **Pump Operating Hours** is the number of hours that the pump has operated.
- **Thermal Enclosure Temp** is the temperature of components inside the foam insulating enclosure. If red, the instrument is either too hot and unable to regulate the enclosure temperature, or too cold and in a warmup state. Normally this is between 51.5 °C and 57.5 °C.
- **Cavity Temperature** is the optical bench temperature. If red, the instrument is either too hot and unable to regulate the cavity temperature, or too cold and in a warmup state. Normally this is between 52 °C and 58 °C.
- **Laser Temperature** is the temperature of the diode laser. If red, the instrument is unable to regulate the laser temperature.
- **Laser Temp. Shift** is the shift in the laser center wavelength from the factory calibration.
- **Ring Down Time** is a parameter indicating cavity resonance.
- **Device Uptime** shows the number of hours that the instrument has been powered on.
- **On/Off cycles** is the number of times the instrument has been powered on.

Layouts

You can customize the graphical layout. If, for example, you are only interested in viewing N_2O measurements, you can select a layout that displays one gas and then select the gas of interest.

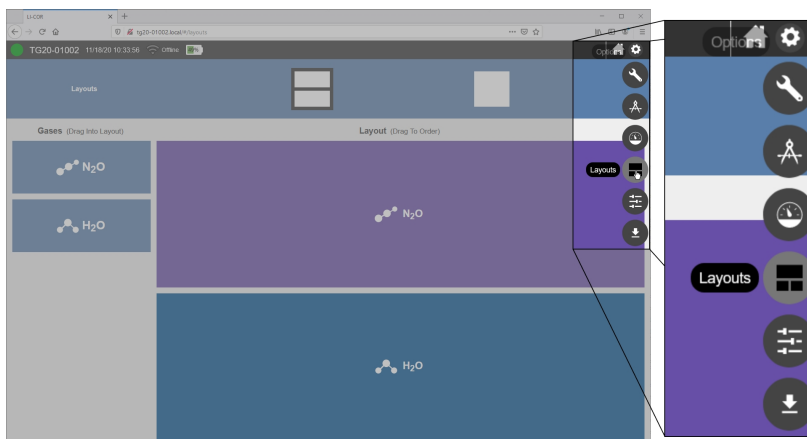

Thresholds

The software provides simple, configurable indicators of whether the measured gas concentration exceeds or drops below a threshold. It provides color-coded indicators when the measured gas is within or outside of the specified range. When you have set a **Low Threshold** or **High Threshold** for a gas, the home page will indicate if the measurement is outside of the threshold on the graph with anomaly stripes (click **Hide/Show Anomaly Stripes**; ) and the status by color coding the reported values. You can change the colors by clicking **Low Color**, **Middle Color**, or **High Color** on the Thresholds page. Thresholds are for display only; they are not recorded in the data file.

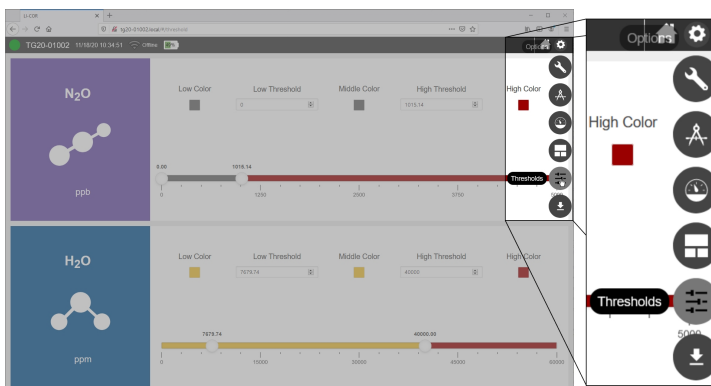

Export

Data are downloaded from the instrument using the **Download** option under **Options > Export**. See *Retrieving data from the instrument* on page 3-9.



Section 5.

Troubleshooting

Here we describe common issues and solutions. If things aren't working as you expect, start here.

Connection problems

Here we describe how to resolve issues related to connecting with the instrument.

Request to connect to instrument network rejected by Android OS

When connecting with the instrument Wi-Fi network, some operating systems may detect that the instrument network is not part of the global internet and reject the connection. This is indicated by a warning similar to "**The network has no internet access. Stay connected?**" Select **Yes**.

- The exact procedure may vary depending upon the device manufacturer.
- The web browser may continue to try to resolve the hostname to an IP address unsuccessfully. In this case, simply enter the instrument fixed IP address into the address bar. For trace gas analyzers, it is 192.168.10.1.

Request to connect to instrument network rejected by iOS

Some iOS configurations may reject the connection and report "**Unable to join the network. If your network security is managed by WiFi address, you may need to turn off Private Wi-Fi Address or modify network settings.**"

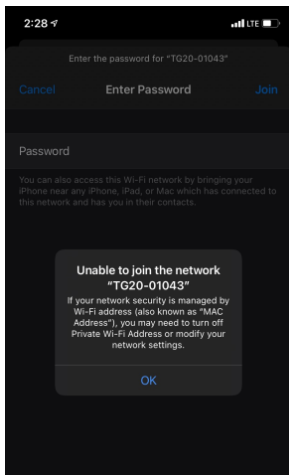

To resolve it, tap the information icon next to the device network and disable the **Private Network** setting.

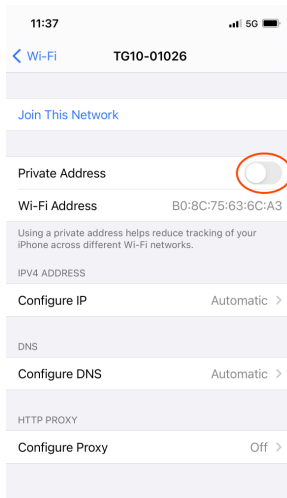
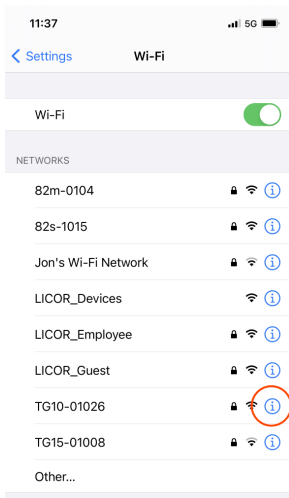

Other wireless connection problems

Try again a few times. The issue could be related to transient heavy network traffic. Some network channels may be transmitting a lot of data (like videos, for example), causing communication to time out.

Wireless networking turned off? If you are attempting to connect over wireless, be sure it is enabled in the software. The display will show a wireless network symbol () when enabled. If wireless networking needs to be enabled, connect with a wired network connection and enable it.

Computer or mobile device connected to the instrument network? If using wireless, be sure you have connected your PC to the instrument's Wi-Fi network before connecting in the web browser.

Too many devices in a confined space? We have experienced wireless connection issues when several wireless devices are close together. Move your instrument to a different room or another place where there are fewer wireless devices.

Wireless antenna unplugged? The wireless antenna is adhered to the internal plastic electronics shroud. It has a very small connector that plugs into the circuit board. Power off the instrument, remove the cover screws, and lift the cover slightly to see if the antenna is attached to the connector on the circuit board. The connector is near the lower left corner of the processor. If it is unplugged from the circuit board, reattach it and try to connect again.

See *Figure B-3* on page B-5

Unable to connect with the instrument over a wired connection

Network cable disconnected? Check both ends to be sure it is connected to the instrument and to your computer or network.

Instrument on a different network than PC? If you are using an Ethernet cable, be sure the instrument network cable and your PC network cable are connected to the same local network.

Network not detected by the instrument? Check the IP address given on the instrument display. If the display says IP:down, the instrument is not detecting a suitable network (the network cable may be unplugged, network switch or routers may be powered off, the IP address setting in the instrument may be incompatible with the network or computer).

IP address setting incompatible with the network settings? If the instrument IP address or your computer's IP address is set to static, you may need to alter either your computer or instrument network configuration. To restore connectivity, make

the computer IP address compatible with the instrument IP address. This procedure may work on Windows 10:





- 1 Press the Windows key () or the Windows key + R ( + R), type `cmd`, and press **Enter** to open the command prompt.
- 2 Type `ipconfig` and press **Enter**.
Your computer will reply with its network configuration information. You're interested in the IPv4 Address.
- 3 Compare your computer's IP address with the instrument's IP address given on the display. If the IP addresses are not compatible (see *Table 5-1* below), you will not be able to connect until you have changed one or both IP addresses.

Table 5-1. Incompatible IP addresses that will lead to connection issues.

| Device | IP Address | Issue | Potential Solution |
|---------------|------------|--|------------------------------------|
| LI-78xx PC | 172.24.1.1 | Same IP address (the last set of octets must be different) | Change PC IP address to 172.24.1.2 |
| Device | IP Address | Issue | Potential Solution |
| LI-78xx PC | 172.24.1.1 | Different network (the first two or three octets must be the same) | Change PC IP address to 172.24.1.2 |

To change your computer's IP address (Windows 10):

- 1 Open the **Network Connections** window.
 - Press the Windows key () , type `Network Connections`, and press **Enter**.
 - Press the Windows key + R ( + R) and type `ncpa.cpl` and press **Enter**.
- 2 In the Network Connections window, double click the icon that represents your network connection, and then click **Properties**.
- 3 Double click **Internet Protocol Version 4 (TCP/IP)** to open the IPv4 Window.
- 4 In the window that opens, select **Use the following IP address** and enter an IP address that is compatible with the instrument IP address. The first three octets will be the same as the instrument IP address, but the final set of octets must be different.

| Device | Compatible IP Addresses |
|---------|-------------------------|
| LI-78xx | 172.24.1.1 |
| Device | Compatible IP Addresses |

| Device | Compatible IP Addresses |
|---------|-----------------------------------|
| PC | 172.24.1.2 through 172.24.1.255 |
| Device | Compatible IP Addresses |
| LI-78xx | 192.168.1.1 |
| PC | 192.168.1.2 through 192.168.1.255 |

- 5 Connect with the instrument by entering the host name in a web browser address bar.
- 6 Now you can change the instrument IP address settings to whatever you prefer. Connection issues will be resolved if you set both the instrument and your computer to **automatic**.

Note: You must reconnect after changing the instrument IP address.

Measurement problems

Here we describe issues related to the display of data or measurements.

Readings drift or step change unexpectedly

Constricted inlet or outlet? If one of these becomes constricted, you will observe errant measurements, with corresponding status codes that indicate problematic pressure measurements (see *Status codes* on page 2-10). Clear the constriction and the instrument should return to normal operation in a few minutes. Restart the instrument if it does not resume normal operation within a few minutes.

Pressure readings are questionable or unstable

Clogged air inlet filter? Check and replace the filter if needed, as described in *Replacing the air inlet filter* on page 6-4. Otherwise, unstable pressure readings may indicate that the pump is failing. Contact technical support if the issue is not resolved by replacing the filter.

Gas density measurements appear to have oscillations

In older firmware, regular, periodic oscillations in the data may appear in circumstances where there are vibrations that are effectively coupled to the instrument sampling frequency. Typically, these oscillations are small and the measurements are still within the noise specification.

Solution: Update the instrument firmware to v2.1.37 or newer. The latest firmware adjusts the pump speed automatically to prevent this issue.

Interface issues

Some issues related to the display settings are described here.

The interface is in a language that I don't understand

The interface can be displayed in English, Spanish, and Simplified Chinese. If you need to change the language setting, click **Options > Settings**. The language setting is stored in the web browser. Any time you connect with a browser for the first time or clear your browser cache, the language setting will be in the default state (English).

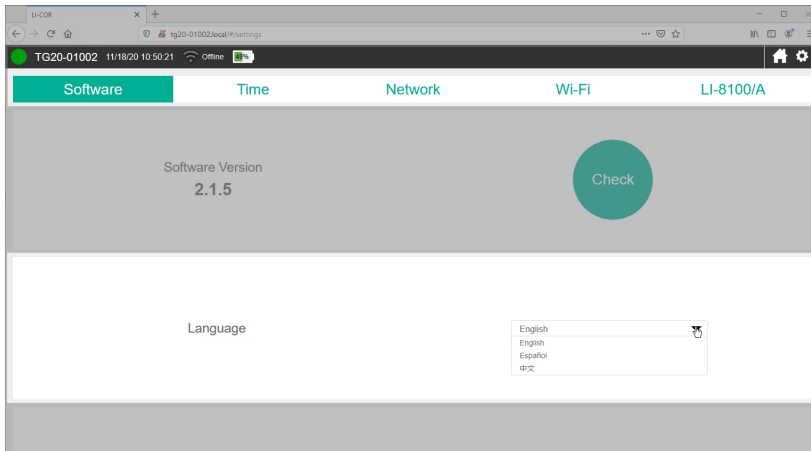

Graphed data overlaps in time or has gaps

If you have been altering the time and time zone settings, the browser may receive overlapping time information. Refresh your web browser to reload the display. The issue should be resolved. Data are always logged with the Unix time.

Status and warning messages

During warmup and any time the instrument detects a problem, it will issue one or more status messages, including a message that says SVC Required. This is normal during warmup. Typically, warmup messages will be resolved within an hour of operation. The status messages will be triggered again if there is an issue with the system.

See *Status codes* on page 2-10 for details on the codes.

Code 128 triggered

Code 128 is triggered if the inlet is obstructed. This can happen if the instrument has drawn water, dust, or debris into the inlet filter, causing a clog. In either case, power off the instrument, clear the obstruction, replace the filters (see *Replacing the air inlet filter* on page 6-4), and power the instrument back on.

You must restart the instrument to resolve code 128.

Section 6.

Maintenance

The LI-7820 will require little maintenance. There are no user-serviceable parts in the instrument except for the air inlet filter, air dry-down chemical, and pump. Do not attempt to disassemble the instrument or conduct any maintenance procedures other than those described here.

Instrument calibration

To adjust the instrument calibration, you can set the zero and span. The span is like a slope (the m in $y = mx + b$). The zero is a spectral baseline. Adjusting the zero changes every measurement (the relationship is non-linear). Adjusting the span changes the slope. Calibration gases should be at a pressure between ambient and 35 kPa (5 PSI) above ambient pressure. We recommend installing a >30 cm vent before the air inlet to vent the excess pressure and prevent diffusion of ambient air into the gas stream.

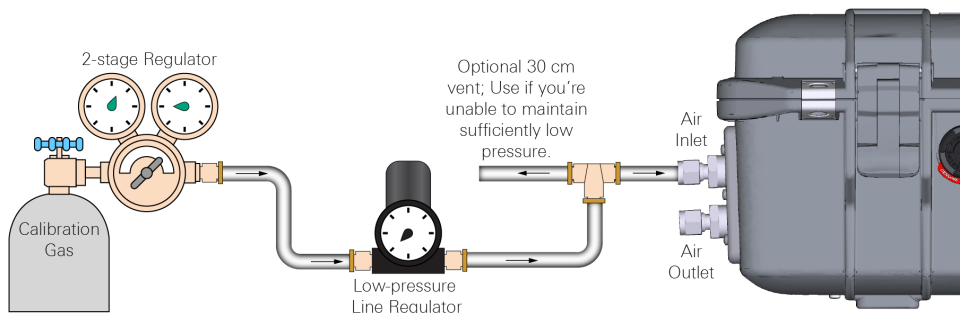

Figure 6-1. Plumbing configuration for calibration gases. Use a low pressure regulator to reduce pressure and a 30 cm vent to avoid pressurizing the inlet.

Setting the N₂O span and zero

Select quality zero and span gases that are balanced in air or manufactured air (nitrogen and oxygen). The zero gas should be 0 ppb N₂O. For the best span adjustment, select a quality span gas with a N₂O concentration near or slightly above the concentrations you expect to measure. The calibrations will only be as good as the gases.

Caution: Do not use nitrogen-balanced gas. Use air-balanced gas for both the zero and span. Do not power on the instrument with a 0 ppm N₂O gas flowing through the analyzer or the analyzer will not initialize properly.

- 1 Connect a tank of N₂O in dry air or manufactured air to the air inlet (*Figure 6-1* on the previous page).
The span gas will work for this.
- 2 Set the pressure between ambient and 35 kPa (5 PSI) above ambient.
- 3 Observe the measurements on the home screen until the N₂O has stabilized.
The slope will be near zero.
- 4 Being careful to avoid introducing any H₂O into the air, switch to the zero gas.
It is important that the air remain dry when changing from the span to the zero gas.
- 5 Wait for the zero reading to stabilize, then set the N₂O zero.
Under **Options > Calibration**, click **Zero**. The software will indicate that a zero calibration has started and it will not report concentrations until the zero is set. This usually takes about 5 minutes.

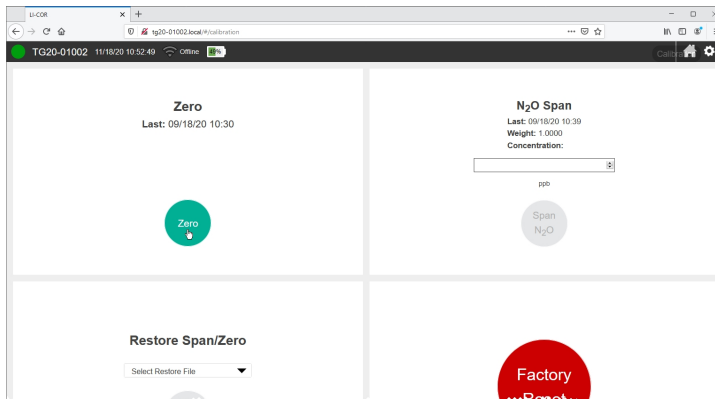

- 6 Switch back to the N₂O span gas.

7 Wait for the reading to stabilize.

Under **Options > Calibration > N₂O Span**, enter the concentration of the gas and click **Span N₂O**.

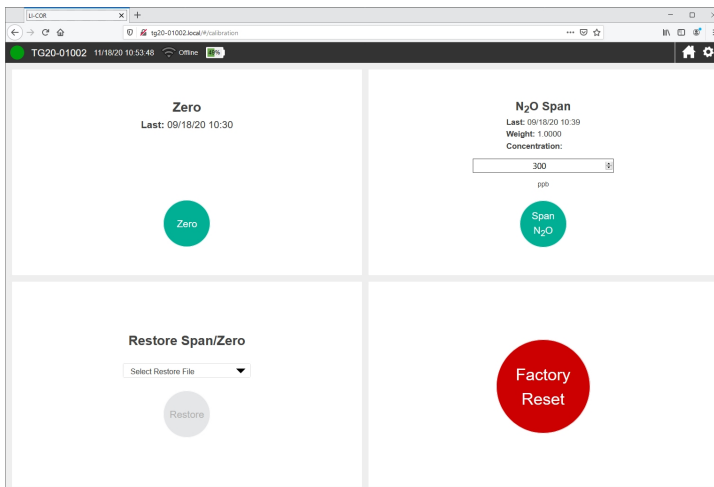

Recovering from a bad calibration

In the event that an attempt to zero or span fails to work as intended, you can restore previous zero and span settings by selecting the file and clicking **Restore**.

Factory Reset reloads the factory original zero and span calibration parameters.

Replacing the air inlet filter

The air intake has filters that may become contaminated periodically. We recommend replacing filters every year, or more often if you are sampling dirty or dusty air. The filters also should help prevent water from being drawn into the gas analyzer.

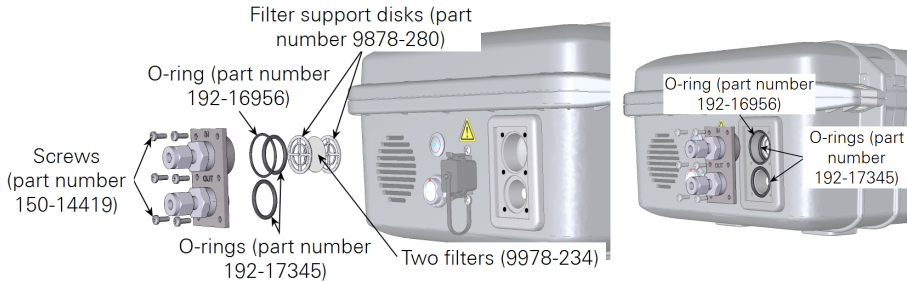

- 1** Power off the instrument.
- 2** Remove each of the six screws that secure the air intake and outlet.
They are installed with thread locking compound, which will make them difficult to remove.
- 3** Remove the O-rings, the filter support disks, and the filter.
Use a toothpick to work them out.
- 4** Inspect the O-rings and replace them if they are damaged or compressed.
- 5** Install the replacement filters and reassemble the system.

Install *two* filters (part number 9978-234) between the support disks. The two metal discs support the filter(s) — one on each side. Align the centers of the filters and the metal disks. Assembly is the reverse of disassembly. You do not need to use thread locking compound on the threads. Tighten them snugly.

Replacing the purge dry-down chemical

Replacement desiccant (622-17627) is included with the instrument spares. The desiccant, consisting of silica gel beads, is contained in a non-porous tube (see *Figure 6-2* below). The instrument will pump air through the desiccant tube during power-off to purge the optics of water vapor. You may need to replace or restore the desiccant periodically. The silica gel beads are orange when new and green when saturated (see *Figure 6-3* on page 6-7).



Warning: *May cause irritation. MAY CAUSE SKIN IRRITATION. MAY CAUSE RESPIRATORY TRACT IRRITATION. MAY CAUSE PAIN, NAUSEA, VOMITING AND DIARRHEA. May result in coughing and/or sore throat. PROLONGED OR REPEATED EXPOSURE TO DUST MAY CAUSE PULMONARY PROBLEMS. INGESTION MAY CAUSE GASTRIC DISTURBANCES.*

Advertissment: *Peut causer une irritation. PEUT CAUSER UNE IRRITATION DE LA PEAU. PEUT CAUSER UNE IRRITATION DE LA VOIE RESPIRATOIRE. PEUT CAUSER DOULEURS, NAUSÉE, VOMISSEMENTS ET DIARRHÉE. Peut entraîner une toux et / ou un mal de gorge. L'EXPOSITION PROLONGÉE OU RÉPÉTÉE A LA POUSSIÈRE PEUT CAUSER DES PROBLÈMES PULMONAIRES. L'INGESTION PEUT CAUSER DES PERTURBATIONS GASTRIQUES.*

Desiccant replacement instructions

- 1 Power off the instrument.
- 2 Open the lid and locate the purge chemical column.
- 3 Disconnect the quick-connect fittings from the column inlet and outlet.

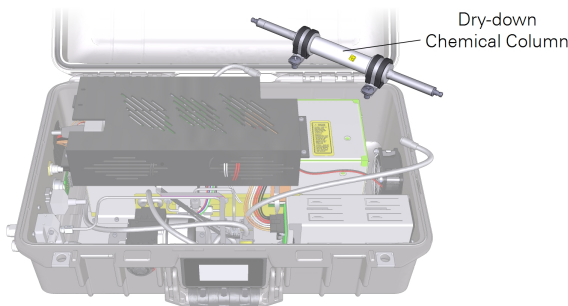

Figure 6-2. Location of the silica gel dry-down column.

4 Remove the column.

It is secured with two screws. Remove them. When the column mounting brackets are removed, the column can come apart easily, and the silica gel beads can fall out. Be careful when handling the column so that it does not come apart.

5 HOLDING THE COLUMN AWAY FROM THE CASE, separate one end by grasping one cap and pulling it off of the column.

Pour out the silica gel beads. The desiccant can be regenerated (see *Regenerating the desiccant* on the facing page) or disposed of in municipal waste.

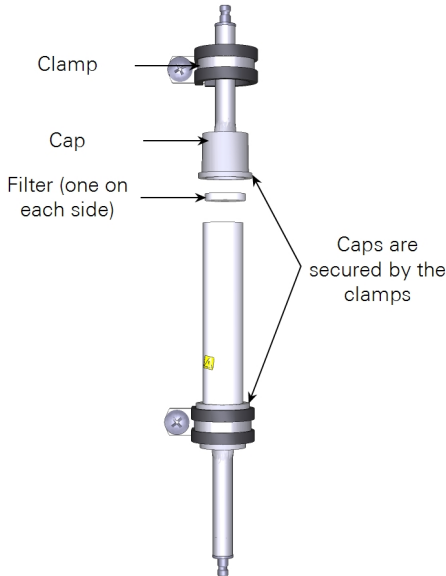

6 Locate a new packet of silica gel beads in the accessories kit.

7 Fill the column with fresh silica gel beads.

There may be a little more than is needed. Dispose of the extra silica gel beads or keep them sealed in a glass jar.

8 Reassemble the filter and caps; connect the tubes, and tighten the screw clamps securely.

Important: Tighten the clamp screws securely. The clamps hold the caps onto the tube; the caps hold the silica gel beads in the tube. If the clamps are not tight, the caps will be forced off when the tube is pressurized during shutdown. The tube will open and the silica gel beads will spill in the case. It is a situation easily avoided by tightening the clamp screws securely.

Regenerating the desiccant

Indicating silica gel can be regenerated in a drying oven. This preparation of silica gel is green when it is saturated and orange when it is new or restored.

- 1 Preheat the oven to 120 °C (248 °F).
- 2 Spread a single layer of the granules in a shallow pan.
- 3 Place in the oven for 60 to 120 minutes.

Less heat for a longer time will not work, nor will more heat for less time.

- 4 After the orange color is restored, place the hot, regenerated material into a glass container and close the lid while it is still hot.

Do not place hot beads into a plastic container. Store the regenerated desiccant in a sealed glass jar. Avoid storing the beads in a plastic container.

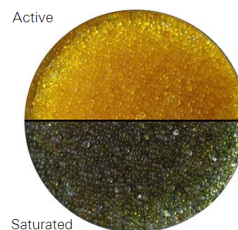
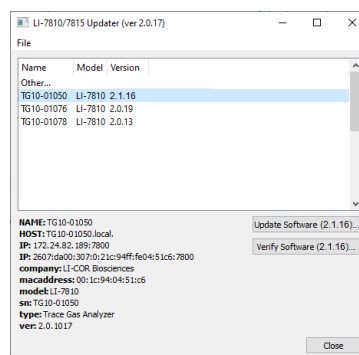

Figure 6-3. Active and saturated desiccant.

Note: If the Sorbead turns black, you've overheated it and it needs to be replaced. Sorbead beads may break over time but the performance is not affected.

Software updates

Software updates will be released periodically to provide new features and bug fixes. You can check for updates through the interface (click **Settings > Software > Check**) or on the LI-COR technical support website. Download the updater application and install it on your computer (Windows only). Launch the application. It will display a list of all LI-7810, LI-7815, and LI-7820 instruments on your network. The instrument that you want to update must be connected to your network or computer. Select one to update and click **Update Software**. The update will take several minutes. The instrument will restart when the update is complete.



Section 7.

Communication with the MQTT protocol

The LI-7820 Trace Gas Analyzers can communicate with devices using the Message Queuing Telemetry Transport (MQTT) protocol. MQTT is a machine-to-machine communication protocol that supports many programming languages, described at github.com/mqtt/mqtt.github.io/wiki/libraries. The instrument uses the Eclipse Mosquitto, an open source MQTT broker.

Here we provide basic examples that describe how to read data from the instrument in a terminal program, send and receive calibration information in a terminal program, and how to save data to a computer using a simple script written in the Python language. These tutorials are for novice users.

Terminology

Here we provide a simple summary of terminology used in MQTT. These terms are described in greater detail by other online resources.

- **Server:** The Trace Gas Analyzer is a server that sends information.
- **Client:** The computer or device that is receiving information. The server (e.g., Trace Gas Analyzer) can communicate with any client device that is configured to run an acceptable programming language.
- **Broker:** Software that mediates communication between the server (Trace Gas Analyzer) and client (your computer or data logger).
- **Topic:** A collection of information that the servers sends.
- **Subscribe:** A client's request for a topic; the client subscribes to a topic. When subscribed, the publisher sends that topic to the client.
- **Publish:** The act of sending a topic to a client.

Table 7-1. Topics and hierarchy in the LI-7820.

| Topic | Description | Hierarchy |
|-------|--|---|
| 1 | Data | licor/niobrara/output/concentration |
| 2 | Header for the data file | licor/niobrara/output/concentration/units |
| 3 | Diagnostic information for data | licor/niobrara/output/diagnostics |
| 4 | Header for diagnostic information | licor/niobrara/output/diagnostics/units |
| 5 | Set and read the calibration baseline (0) | licor/niobrara/cfg/Start_Peak_Base_Line_Cal |
| 6 | Set N ₂ O span calibration | licor/niobrara/system/N2O_Span |
| 7 | Read the N ₂ O span calibration | licor/niobrara/cfg/N2O_Span |

Basic commands in a terminal program

The instrument can be controlled from a terminal program (macOS) or command prompt program (Windows). With trace gas analyzers, that means you can set the zero and span calibrations, read the calibrations, and read data with diagnostics. In the following section, we describe how to perform these basic functions.

This tutorial uses Eclipse Mosquitto, an open source message broker from the Eclipse Foundation which can be downloaded from mosquitto.org/download/. Install it on your computer. We will use two components of mosquitto for this tutorial: `mosquitto_pub`, which "publishes" information to the instrument (as in, sets the span calibration); and `mosquitto_sub`, which "subscribes" to information from the instrument, such as current calibration parameters, and measurements.

Streaming data into the interface

This tutorial subscribes to the `data` topic. Subscribing is described in depth at mosquitto.org/man/mosquitto_sub-1.html.

- 1 Launch the terminal or command prompt and open the directory that has the Mosquitto apps. The default directory is `Program Files\mosquitto`.

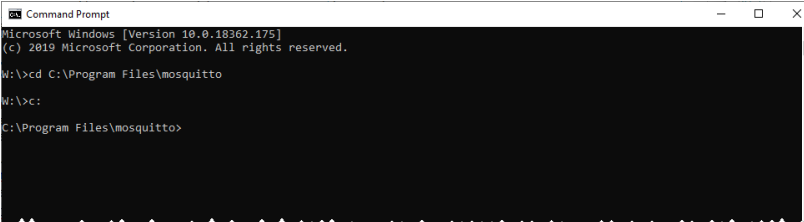

```

Microsoft Windows [Version 10.0.18362.175]
(c) 2019 Microsoft Corporation. All rights reserved.

W:\>cd C:\Program Files\mosquitto
W:\>c:
C:\Program Files\mosquitto>
  
```

- 2 Enter the following command to subscribe to the topic.

```

mosquitto_sub -h 172.24.82.41 -t
"licor/niobrara/output/concentration"
  
```

- `mosquitto_sub` launches the application to subscribe.
- `-h` specifies a host (the Trace Gas Analyzer) followed by the instrument IP address
- `172.24.82.41` is the instrument IP address. You can also enter the host name. Both are given on the instrument display.
- `-t` specifies that you want to subscribe to a topic.
- `"licor/niobrara/output/concentration"` is the topic and hierarchy.

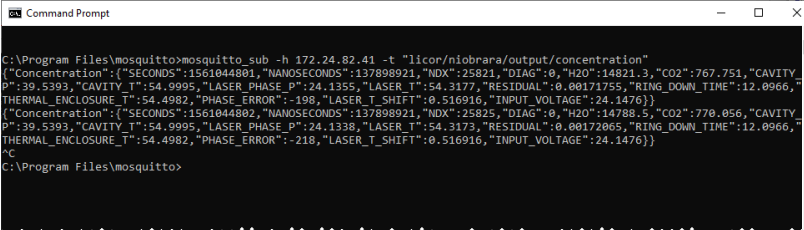

```

C:\Program Files\mosquitto>mosquitto_sub -h 172.24.82.41 -t "licor/niobrara/output/concentration"
{"Concentration":{"SECONDS":1561044801,"NANOSECONDS":137898921,"NDX":25821,"DIAG":0,"H2O":14821.3,"CO2":767.751,"CAVITY_P":39.5393,"CAVITY_T":54.9995,"LASER_PHASE_P":24.1355,"LASER_T":54.3177,"RESIDUAL":0.00171755,"RING_DOWN_TIME":12.0966,"THERMAL_ENCLOSURE_T":54.4982,"PHASE_ERROR":-198,"LASER_T_SHIFT":0.516916,"INPUT_VOLTAGE":24.1476}}
{"Concentration":{"SECONDS":1561044802,"NANOSECONDS":137898921,"NDX":25825,"DIAG":0,"H2O":14788.5,"CO2":770.056,"CAVITY_P":39.5393,"CAVITY_T":54.9995,"LASER_PHASE_P":24.1338,"LASER_T":54.3173,"RESIDUAL":0.00172065,"RING_DOWN_TIME":12.0966,"THERMAL_ENCLOSURE_T":54.4982,"PHASE_ERROR":-218,"LASER_T_SHIFT":0.516916,"INPUT_VOLTAGE":24.1476}}
^C
C:\Program Files\mosquitto>
  
```

- 3 Type `Ctrl + C` to stop the script.

Setting the zero calibration

This tutorial publishes to the `cfg` topic. Publishing is described in detail at mosquitto.org/man/mosquitto_pub-1.html. Select a quality gas and plumb it zero gas to the analyzer air inlet, letting the excess pressure vent to the room.

- 1 To start a zero calibration, enter:

```
mosquitto_pub -h 172.24.82.41 -t "licor/niobrara/cfg/Start_Peak_Base_Line_Cal" -m
```

- `mosquitto_pub` launches the application to publish (send to the instrument).
- `-h` specifies a host (the Trace Gas Analyzer) followed by the instrument IP address
- `172.24.82.41` is the IP address. You can also enter the host name. Both are given on the instrument display.
- `-t` specifies that you want to subscribe to a topic.
- `"licor/niobrara/cfg/Start_Peak_Base_Line_Cal"` is the topic and hierarchy.
- `-m` specifies that you are sending a message from the command line.
- `"1"` is the message.

This command initiates the baseline calibration. The process takes several minutes (up to 5 minutes). Wait until the process is finished before moving on to other commands.

- 2 To check if the zero is complete, enter the command:

```
mosquitto_sub -h 172.24.82.41 -t "licor/niobrara/cfg/Start_Peak_Base_Line_Cal"
```

The instrument will reply with `"0"`.

- 3 Type `Ctrl + C` to stop the script.

Setting the span calibration

Follow suitable spanning procedures, as described in *Maintenance* on page 6-1.

Plumb a span gas to the analyzer air inlet. Use a span gas balanced in air (do not use a nitrogen-balanced gas).

- 1 To start a span calibration, enter:

```
mosquitto_pub -h 172.24.82.42 -t "licor/niobrara/system/N2O_Span" -m "<N2O tank in ppb>"
```

- `mosquitto_pub` launches the application to publish (send to the instrument).
- `-h` specifies a host (the Trace Gas Analyzer) followed by the instrument IP address
- `172.24.82.4x` is the IP address. You can also enter the host name. Both are given on the instrument display.
- `-t` specifies that you want to subscribe to a topic.
- `"licor/niobrara/system/N2O_Span"` is the topic and hierarchy for the LI-7820.
- `-m` specifies that you are sending a message from the command line.
- `"<N2O tank in ppb>"` is the N₂O concentration in PPB.

This initiates the span calibration in the LI-7820. The span is implemented immediately.

- 2 To check if the span is complete, enter the command:

```
mosquitto_sub -h 172.24.82.42 -t "licor/niobrara/cfg/N2O_Span"
```

The instrument will reply with the span value (near 1) like `"1.00242"`

- 3 Type `Ctrl + C` to stop the script.

Rebooting the instrument

To restart the instrument, send the following command:

```
mosquitto_pub -h 172.24.82.41 -t  
"licor/niobrara/system/reboot" -m "reboot"
```

This initiates the restart cycle, beginning with a purge of the optics.

Powering off the instrument

To power off the instrument, send the following command:

```
mosquitto_pub -h 172.24.82.41 -t  
"licor/niobrara/system/shutdown" -m "shutdown"
```

This initiates the shutdown, beginning with a purge of the optics. There is no command to power on the instrument remotely.

Basic commands with a Python script

Python scripts can be used in Windows, macOS, and Linux operating systems, and with other computing devices. Here we describe some basic processes on Windows and macOS computers.

Configuring paho-mqtt in Windows

Python is not included with Windows by default, but you can download a suitable version from the Microsoft Store.

- 1 Download Python and install it on your computer.

Press the Windows key () to open the search bar. Type `Store` and press **Enter** to open the store. In the store, search for Python. Install Python 3.7.

- 2 Launch the command prompt program.

Press () to open the search bar. Type `Command Prompt` and press **Enter**.

- 3 Install Eclipse Paho on your computer.

Type `pip install paho-mqtt` and press **Enter**. The terminal program will issue a few replies as it completes the installation. Now your computer should have all of the files needed to communicate with the instrument.

Configuring paho-mqtt in Mac or Linux

Although Mac computers include Python by default, you need to install some additional libraries. This is done in the command line interface.

- 1 Launch the terminal program.

Type `CMD + Space` to open the search bar. Type `Terminal`, and press **Return**.

- 2 Install the PIP package manager for python

Type `easy_install pip` and press **Return**. If you get an error, type `sudo easy_install pip`.

- 3 Install Eclipse Paho on your computer.

Type `pip install paho-mqtt` and press **Return**. If you get an error, type `sudo pip install paho-mqtt`. The terminal program will issue a few replies as it completes the installation. Now your computer should have all of the files needed to communicate with the instrument.

Streaming data into the Terminal Program

These are basic steps you'll follow to see data streamed into a terminal program on macOS or the command prompt on Windows. Before attempting to connect with the instrument, power it on and let it warm up. Connect the network cable between the instrument and your computer or your local network.

- 1 Create the python script to read data.

Copy the following into a text file and save it to your computer's desktop (or another directory) with a `.py` extension, like `read-data.py`.

```
import paho.mqtt.client as paho

def on_subscribe(client, userdata, mid, granted_qos):
    print("Subscribed: "+str(mid)+" "+str(granted_qos))

def on_message(client, userdata, msg):
    msg = str(msg.payload)
    print(msg)

client = paho.Client()
client.on_subscribe = on_subscribe
client.on_message = on_message

client.connect("172.24.82.41", 1883)
client.subscribe("licor/niobrara/output/concentration", qos=1)
client.loop_forever()
```

- 2 Change the IP Address next to `client.connect` to match that of your instrument. The default port is 1883, so leave that as it is. Save the updated file.

- 3 Run the Python script.

In the terminal program, change to the directory that has the `.py` file saved earlier. Type `cd desktop` on Mac or type `cd C:\Users\User.Name\Desktop` if you saved them to your desktop (`User.Name` is a placeholder, used as an example). Then type `python read-data.py` to launch the script created in step 1. Data will stream into the terminal program.

- 4 Type `Ctrl + C` to stop the script.

Downloading data in a date and time range

The following script will download data from instrument. The script includes a date and time range, file duration (minutes), as well as the directory that the files are saved to, all of which can be modified to suit your needs. This program uses the Python `requests` libraries, so we'll begin by installing those.

- 1 Install the `requests` libraries.

Launch a terminal on Mac or command prompt on Windows. Type `pip install requests` or `sudo pip install requests` in the command line tool. The terminal will issue a few replies indicating success.

- 2 Create the python script to save the data.

Copy the following into a text file and save it to your computer's desktop (or another directory) with a `.py` extension, like `import-datetime.py`.

```
import datetime
import requests
import socket
slnr = 'tgXX-01009.local'
ip = socket.gethostbyname(slnr)
dl1 = "http://" + ip + ":8080/ExportAdvancedData?tmin="
dl2 = "&tmax="
tmz = "-06:00"

dt = datetime.datetime(2019,5, 10,0,0,0)
end = datetime.datetime(2019,5, 11,0,0,0)
step = datetime.timedelta(minutes=30)

fls = []
ts5= []

while dt <= end:
    ts1 = dt.strftime('%Y-%m-%d %H:%M:%S')
    ts3 = dt.strftime('%Y-%m-%d %H-%M-%S')
    ts2 = ts1[0:10] + "T"+ts1[11:]
    ts4 = ts1[0:10] + "T"+ts3[11:] + ".txt";
    ts5.append(ts4)
    fls.append(ts2)
    dt += step
print (fls)
for i in range(0,len(fls)-1,1):
```

```

url = dl1+fls[i]+tmz+dl2+fls[i+1]+tmz
print(url + "\n")
flnm = ts5[i]
print("Downloading to File Name " + flnm +
" from " + url )
r = requests.get(url)
with open("C:/Users/User.Name/Documents/" +
flnm, 'wb') as f:
    f.write(r.content)

```

3 Modify the script for your instrument, computer, and date range:

- A Identify the instrument:** In `snlo='tgXX-01009.local'`, replace `tgXX-01009` with the serial number from your instrument. The letters XX represent numbers.
- B Set the beginning time:** In `dt = datetime.datetime(2019,5, 10,0,0,0)`, specify the start date and time for the data to download. `2019,5, 10` is the year, month, and day (YYYY,M, DD). `0,0,0` is the hour, minutes and seconds (H,M,S).
- C Set the ending time:** In `end = datetime.datetime(2019,5, 11,0,0,0)`, specify the end date and time for the data to download.
- D Specify the file size (minutes):** In `step = datetime.timedelta(minutes=30)`, change the value 30 to the number of minutes you want.
- E Set the directory to save the data:** In `with open("C:/User-
s/User.Name/Documents/" + flnm, 'wb')`, specify the directory.

4 Start the script from the terminal program or command prompt.

In the terminal program, change to the directory that has the `.py` file saved earlier. Type `cd desktop` on Mac or type `cd C:\Users\User.Name\Desktop` if you saved them to your desktop (`User.Name` is a placeholder, used as an example). Then type `python import-datetime.py` to launch the script. This script will create 48 text files, each with 30 minutes of data recorded on May 5, 2019. The files will be created and saved to the directory you specify.

Additional commands

Python scripts can be also used to set zero/span, reboot, or shutdown the instrument by using the publish option available in the Paho MQTT python client similar to `mosquito_pub`. To shutdown the instrument, send the command

```
client.publish("licor/niobrara/system/shutdown","shutdown")
```

Appendix A.

Measurement overview

To measure gases, the analyzer injects laser light into a V-shaped optical cavity defined by mirrors 1, 2, and 3 (*Figure A-1* below). The mirrors are highly reflective — photons may circulate many times before escaping to strike the sample photodiode. This long effective path-length enhances sensitivity by creating many opportunities for the sample gas flowing through the cavity to absorb light.

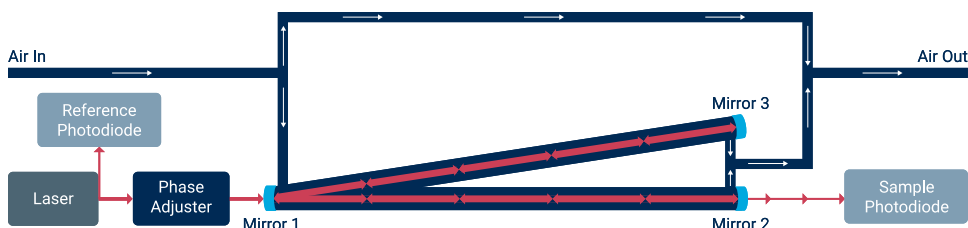

Figure A-1. Simplified schematic of the LI-7820 flow path through the optical bench. The phase adjuster is a volume in the path between the laser and optical bench that is tied to a pressure control mechanism. Changing the pressure of that volume alters the refractive index which subsequently modifies the phase of the laser.

The instrument ramps the laser drive current so the laser scans a range of wavelengths that span absorption features of the gases. A fraction of the photons are allowed to leak from the cavity back into the laser, creating optical feedback that narrows the laser output. This, in turn, couples a large fraction of the laser power to the cavity and locks the laser frequency precisely to the center of a cavity resonance mode.

During a scan, the instrument creates a dense grid of fixed cavity resonance modes that are equally spaced within a few kHz. The laser jumps discretely from one cavity resonance mode to the next.

To measure all three gases, the laser frequency scans across the full spectral range of interest in about 0.25 seconds (see *Figure A-2* below). It uses the reliably fixed grid spacing in combination with spectroscopic data to determine the exact frequency of each mode. The instrument uses two ring down events—one at the beginning and one at the end of a scan—to normalize the measured signal.

Absorption is computed at each resonance mode by comparing the normalized sample photodiode signal with the reference photodiode signal. The concentration of each gas is then determined by using a fitting algorithm that compares the measured absorption spectrum with internally stored high resolution spectrum.

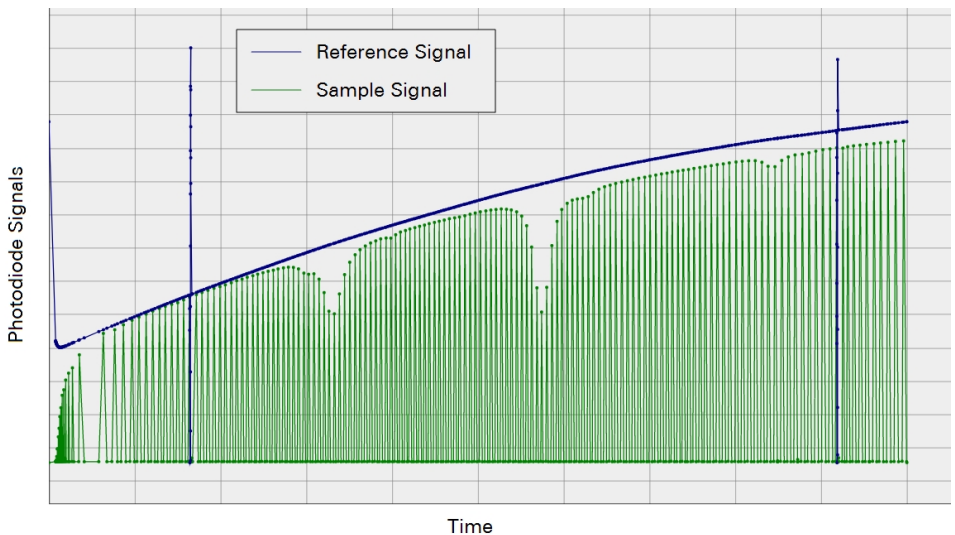

Figure A-2. Example of a scan showing the absorption features for a number of gases. The upper line (dark blue) is the reference signal, and the lower line (green) is the sample signal at each of cavity resonance modes.

Appendix B.

Additional safety information

This section provides information about the safe use of the instrument, wireless channels, and disposal of batteries.

Laser safety labels

The instrument has two laser safety labels: one inside the case and one on the back of the case.



Warning: *The use of controls, adjustments, or the performance of procedures other than those specified herein may result in hazardous radiation exposure.*

Advertissment: *L'utilisation des contrôles, d'ajustements, ou l'exécution des procédures autres que celles spécifiées ici peuvent entraîner une exposition dangereuse aux radiations.*

The LI-7820 is certified as a Class I laser product. No hazardous radiation is emitted from the instrument. Any laser radiation emitted is below the Class I laser limits during all phases of user operation. The laser emits (internally only) at approximately 2121 nm and has a Class 1M peak power rating of up to 75 milliwatts but is permanently set to <15 mW. This instrument complies with the CDRH regulations for laser products (CDRH radiation performance standard 21, Code of Federal Regulations Chapter 1, Subchapter J). Compliance for products marketed in the United States is mandatory.



Figure B-1. The Class 1 laser safety label is affixed to the back of the case.

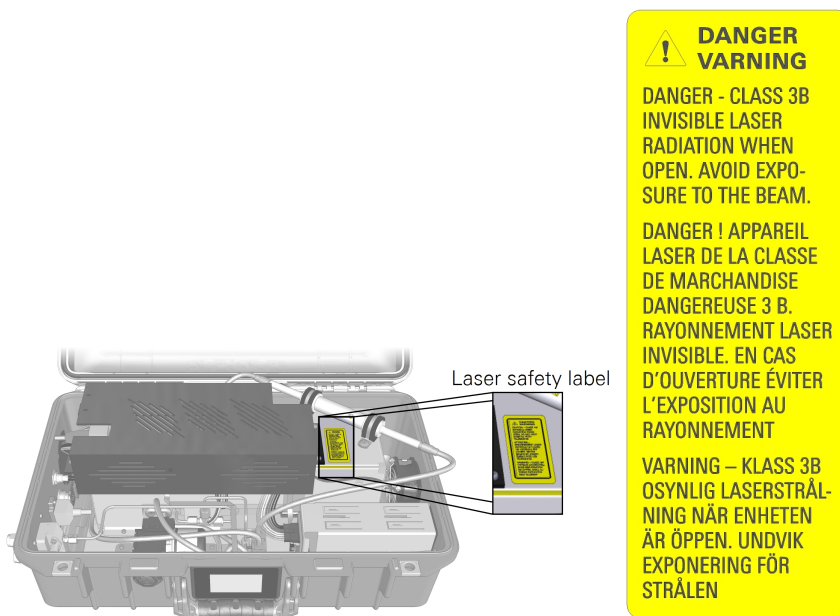

Figure B-2. The laser radiation safety label is inside the instrument case.

Wireless communication notice

The instrument is equipped with wireless communication (Wi-Fi™) capabilities. Wi-Fi communication conforms to the requirements in this section. See *Connecting over wireless* on page 2-5 for more details.

| Channel Number | Lower Frequency (mHz) | Center Frequency (mHz) | Upper Frequency (mHz) |
|----------------|-----------------------|------------------------|-----------------------|
| 1 | 2401 | 2412 | 2423 |
| 2 | 2406 | 2417 | 2428 |
| 3 | 2411 | 2422 | 2433 |
| 4 | 2416 | 2427 | 2438 |
| 5 | 2421 | 2432 | 2443 |
| 6 | 2426 | 2437 | 2448 |
| 7 | 2431 | 2442 | 2453 |
| 8 | 2436 | 2447 | 2458 |
| 9 | 2441 | 2452 | 2463 |
| 10 | 2446 | 2457 | 2468 |
| 11 | 2451 | 2462 | 2473 |

Radio transmission power is given in *Table B-1* below.

Table B-1. Radio transmission power.

| Network Type | Transmission Power |
|--------------|--------------------|
| 802.11b | 10.5 dBm |
| 802.11g/n | 11 dBm |

Battery warnings and disposal



The instrument includes rechargeable lithium ion batteries and CR lithium batteries, which must be disposed of safely. The primary batteries are accessible through the battery cover on the case. The coin-cell batteries are in the case under an electronics shroud.



Warning: *Lithium ion batteries may cause environmental damage or damage to human health if they are disposed of improperly. Do not dispose of the batteries in unsorted municipal waste or an incinerator. Many localities have battery recycling facilities that will accept lithium ion batteries. Check your local regulations to determine how to safely dispose of the batteries.*

Advertissment: *Les batteries lithium ion peuvent causer des dommages à l'environnement ou endommager la santé humaine si l'on se débarrasse d'elles de manière inappropriée. Ne vous débarrassez pas des batteries dans des déchets municipaux non triés ou dans un incinérateur. Plusieurs localités ont des installations de recyclage de batteries qui accepteront les batteries lithium ion. Vérifiez vos réglementations locales pour déterminer comment se débarrasser des batteries en toute sécurité.*

Primary batteries

To remove the primary batteries, turn the clasp counter-clockwise $\frac{1}{4}$ turn to open the battery door. Grasp the tab on the battery and pull to remove the battery. There is space for two batteries. Be sure to remove both of them.



Coin-cell battery

The product includes a CR Lithium coin-cell battery, which contains perchlorate material. Special handling may apply. In the U.S. State of California, see www.dtsc.ca.gov/hazardouswaste/perchlorate.

To remove the coin-cell batteries, power off the instrument, remove the batteries, and open the lid to the case. Remove the four screws that secure the electronics shroud. Being careful to avoid straining the Wi-Fi antenna (it is glued to the shroud), move the shroud to the side. The battery is near the middle of the instrument. The battery is held in with friction. Press it out. Insert a replacement battery with the positive (+) pole facing up.

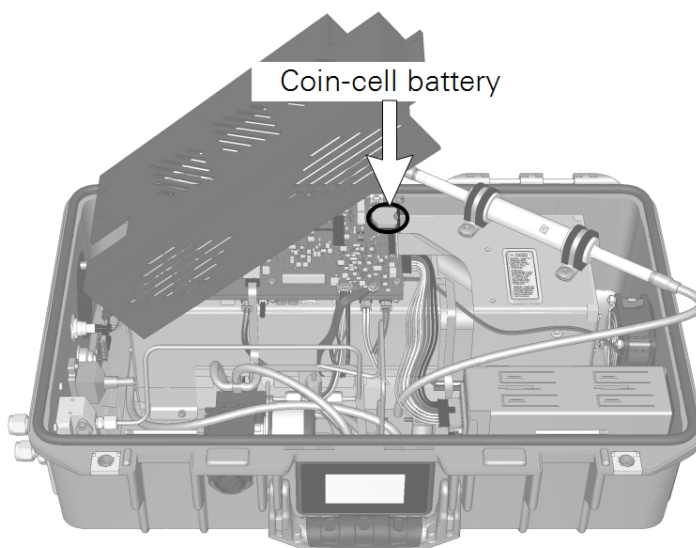

Figure B-3. Carefully lift the shroud as shown to avoid straining the Wi-Fi antenna, which is attached to the shroud.

Appendix C.

Specifications

General

Measurement Technique: OF-CEAS (Optical Feedback – Cavity Enhanced Absorption Spectroscopy)

Measurement Rate: 1 sample per second (1 Hz)

Optical Cavity Volume: 6.41 cm³

Flow Rate:

250 sccm nominally in standard configuration

150 sccm nominally in high altitude configuration

70 sccm nominally in reduced flow rate configuration with installed kit

Total Weight: 10.5 kg (including batteries)

Case Dimensions: 51 × 33 × 18 cm (L × W × H)

Operating Temperature Range: -25 °C to 45 °C (without solar load)

Operating Humidity Range: 0 to 85% RH (non-condensing, without solar load)

Sample Line Humidity Range: 0 to 99.9% (non-condensing)

Operating Pressure Range:

70 to 110 kPa in standard and reduced flow rate configuration

50 to 110 kPa in high altitude configuration

Connectivity: Ethernet and Wi-Fi (not available in some countries)

Wi-Fi Compatibility: 2.4 GHz, 802.11 a/b/g/n/ac

Power Consumption:

Steady State Operation: 22 Watts at 25 °C without batteries charging

Warmup: Up to 65 W without batteries charging; up to 100 W with batteries charging

Off: Up to 2.3 W when powered from pins 3 and 4 without batteries charging; up to 0.2 W when powered from pins 1 and 5 without batteries charging

Power Supply Requirements:

Pins 1 and 5 (24 VDC Input): Minimum 6 A at 24 V

Pins 3 and 4 (10.5 to 33 VDC Input): Minimum 14 A at 10.5 VDC; 6 A at 24 VDC

Power Supply: Universal Power Adapter (Input: 100 to 240 VAC, 50-60 Hz; Output: 24 VDC)

Battery Life: 8 hours typical with 2 batteries

Data Storage: Up to 5,356,800 records; about 62 days of continuous data collection

Pollution Degree: 2

Over-voltage Category: II

Class 1 Laser Product

N₂O Measurements

Response Time (T₁₀ - T₉₀) all from 0 to 330 ppb:

≤2 seconds in standard configuration

≤3 seconds in high altitude configuration

Range: 0 to 100 ppm

Precision (1σ):

0.40 ppb at 330 ppb with 1 second averaging

0.20 ppb at 330 ppb with 5 second averaging

Maximum Drift: < 1 ppb per 24-hour period

H₂O Measurements

Range: 0 to 60,000 ppm

Precision (1σ):

45 ppm at 10,000 ppm with 1 second averaging

20 ppm at 10,000 ppm with 5 second averaging

Specifications subject to change without notice.

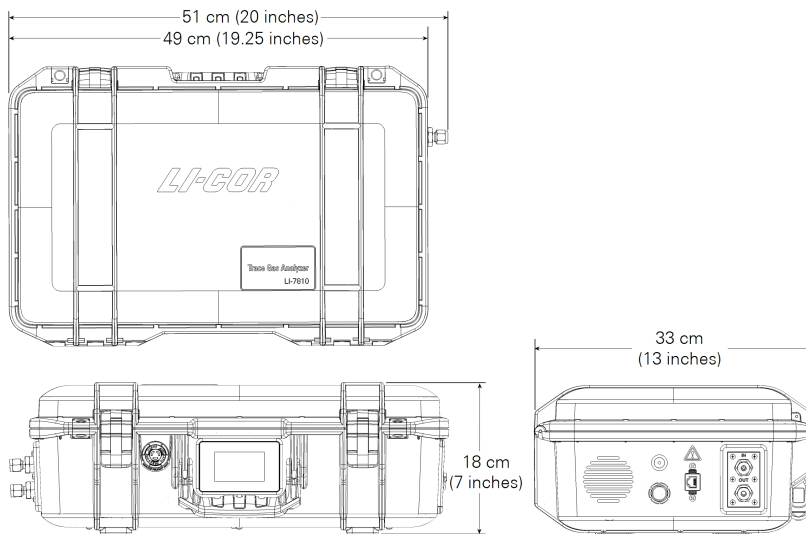

Figure C-1. LI-7820 dimensions. Clearance is required for the power cable and tubing, as well as 2 to 3 cm around the case vents.

Standard Terms and Conditions

1. General. LI-COR Inc. (“LI-COR”) is delivering these goods and products (“Products”) subject to these Terms and Conditions of Sale (“Conditions”). Buyer will be deemed to have assented to these Conditions upon Buyer’s placement of order. Notwithstanding the above, failure of LI-COR to object to provisions contained in any purchase order or other form or document from Buyer shall not be construed as a waiver of these Conditions nor an acceptance of any such provision.
2. Buyer’s Use Only/No Resale. The purchase of Products only conveys to Buyer the non-transferable right for only Buyer to use the quantity of Products and components of Products purchased in compliance with the applicable intended use statement, limited use statement or limited label license, if any, in LI-COR catalogues or on the label or other documentation accompanying the Products (all such statements or licenses being incorporated herein by reference as if set forth herein in their entirety). Buyer has no right to resell the Products, or any portion of them, and any such resale is strictly prohibited unless LI-COR first accepts and approves a purchase order and acknowledges in writing that the Products may be resold by Buyer and the terms of such resales.
3. Prices/Taxes. All prices are quoted for delivery to Buyer when goods are loaded on the carrier at LI-COR premises in Lincoln, Nebraska, USA. Accordingly, unless otherwise specified by LI-COR, prices are exclusive of shipping, insurance and installation charges, all of which are Buyer’s sole responsibility. All prices are exclusive of all sales, use, excise, value added, withholding and other taxes, and all customs, duties, documentation charges, and freights forwarder charges now or hereafter claimed or imposed by any governmental authority upon the sale of the Products. Any such charges will be added to the product invoice or subsequently invoiced to the Buyer. In the event LI-COR is required to pay any such tax, duty or charge, Buyer will promptly reimburse LI-COR.
4. Payment Terms. All payments shall be made in immediately available U.S. Dollars net thirty (30) days from the date of invoice for qualified accounts, without set-off, deduction or withholding of any kind, unless otherwise stated by LI-COR in writing and may be paid by check (drawn on a U.S. bank), wire transfer or major credit card. All open account invoicing must be pre-approved. Any amounts not paid when due will accrue interest at the rate of 1 1/2% per month, or the maximum amount allowed by law, if lower. In the event that any payment is more than thirty (30) days late, LI-COR shall have the right to suspend doing business with Buyer until all past due balances are made current. Buyer shall pay for all costs (including reasonable fees) incurred by LI-COR in connection with the collection of late payments. Each accepted purchase order is a separate, independent transaction, and Buyer has no right of set-off against other purchase orders or other transactions with LI-COR. Buyer hereby grants LI-COR a security interest in the Products in the amount of the unpaid balance of the purchase price until paid in full. LI-COR may file a financing statement for such security interest and Buyer shall sign any such statements or other documentation necessary to perfect LI-COR security interest.
5. Return Policy. Buyer may return non-consumable Products to LI-COR within forty-five (45) days of invoice date only with prior authorization by LI-COR, the Product(s) being returned in new and unused condition and must be resalable as new. Any returned Product(s) are subject to payment of a fifteen percent (15%) re-stocking fee on all items returned. Buyer shall be responsible to make payment to LI-COR for any and all expenses related to deinstallation of the Product(s), including but not limited to shipping, duties, and taxes. All payments subject to this provision shall be made to LI-COR within thirty (30) days of return, or de-installation, of the Product(s).
6. Delays In Performance. LI-COR shall not be liable for any delay in performance hereunder due to unforeseen circumstances or due to circumstances beyond its control including, but not limited to, acts of nature, acts of government, labor disputes, delays in transportation, delays in customs clearance and delays in delivery or inability to deliver by LI-COR’s suppliers.

7. Shipment and Packing. All Product prices exclude costs of shipping and handling and insurance, in accordance with delivery terms designated by LI-COR. Unless otherwise agreed in writing, such costs will be paid by the Buyer and will appear as a separate item on LI-COR invoice. LI-COR shall ship in accordance with LI-COR standard practices. Buyer may specify different shipping instructions, subject to agreement by LI-COR. Unless otherwise agreed to in writing by LI-COR, all products shall be packaged, if appropriate, for shipment and storage in accordance with standard commercial practices. All packing shall conform to carrier requirements.

8. Partial Shipments. Any Products delivered in partial shipments may be invoiced individually. Additional shipping and handling charges may apply.

9. Title/Risk of Loss. All domestic shipments are made FOB per Uniform Commercial Code. All international shipments are made per INCOTERMS 2000 designated by LI-COR. LI-COR title to the Products and the risk of loss of or damage to the Products ordered by the Buyer will pass to Buyer at time of LI-COR delivery of Products to the carrier. The carrier shall be deemed Buyer's agent, and any claims for damages in shipment must be filed with the carrier. LI-COR is authorized to designate a carrier pursuant to LI-COR standard shipping practices unless otherwise specified in writing by Buyer.

10. Intellectual Property Rights. Title to and ownership of the documentation, and any improved, updated, modified or additional parts thereof, and all copyright, patent, trade secret, trademark and other intellectual property rights embodied in the Products, shall at all times remain the property of LI-COR or LI-COR licensors.

11. Acceptance. All sales are final and all Products shall automatically be deemed accepted upon delivery to Buyer when goods are loaded on the carrier at LI-COR premises in Lincoln, Nebraska, USA. Buyer may not return any Products to LI-COR except as provided for by LI-COR warranty or as provided herein.

12. Product Warranties. Unless otherwise specified by LI-COR:

(a) LI-COR warrants that, for a period of twelve (12) months from the date of shipment of the Products from LI-COR (the "Warranty Period"), unless otherwise specified for individual Products or extended by a Support Contract or Extended Warranty Contract, the Products sold hereunder will be free from material defects in materials and workmanship and will conform to LI-COR published specifications in effect as of the date of manufacture. LI-COR SPECIFICALLY DISCLAIMS ANY INDIRECT, SPECIAL, INCIDENTAL OR CONSEQUENTIAL DAMAGES (INCLUDING LOSS OF USE OR LOST PROFITS) WHICH MAY RESULT FROM THE USE OF PRODUCTS PURCHASED HEREUNDER, AS FURTHER SET FORTH IN SECTION 13 OF THESE CONDITIONS OF SALE. This limited warranty extends only to Buyer as original purchaser unless otherwise agreed upon in writing by LI-COR.

(b) The foregoing warranty shall not apply if the defective Product (i) has been subjected to abuse, misuse, neglect, negligence, accident, improper testing, improper installation, improper storage, improper handling or use contrary to any instructions issued by LI-COR, (ii) has been repaired or altered by persons other than LI-COR, (iii) has not been installed, operated, repaired and maintained in accordance with the documentation or operated outside of the environmental specifications for the Product; (iv) has failed due an Act of God, including but not limited to fire, flood, tornado, earthquake, hurricane or lightning or (v) has been used with any devices, accessories or products not manufactured by or approved by LI-COR. In addition, the foregoing warranty shall not apply to Products (i) LI-COR Standard Terms and Conditions of Sale – rev. 5/15/2009 marked or identified as "sample," (ii) loaned or provided to Buyer at no cost, or (iii) which are sold "as is."

(c) If during the Warranty Period: (i) LI-COR is notified promptly in writing upon discovery of any defect in the Product, including a detailed description of such alleged defect, (ii) such Product is returned, transportation charges prepaid, to LI-COR designated manufacturing facility subject to the prior approval of LI-COR with a valid Return Material Authorization ("RMA") number, and (iii) LI-COR inspections and tests determine that the Product is indeed defective and the Product has not been subjected to any of the conditions set forth above, then, as Buyer's sole remedy and LI-COR sole obligation under the foregoing warranty, LI-COR will, at LI-COR option, repair or replace without charge the defective Product. In no event will the Buyer itself nor will the Buyer allow any party other than LI-COR or a third party authorized in writing by LI-COR to perform any service on the Products.

(d) During the Warranty Period, LI-COR will provide on-site warranty repair for Odyssey® Infrared Imager, Aerius Automated Infrared Imager, Pearl® Imager and/ or 4300 DNA Analyzer Products including travel costs, repair parts, and labor to maintain the hardware in proper operating condition. At LI-COR discretion, the Buyer may be required to run certain diagnostic procedures to help determine the source of the problem before on-site warranty repair is rendered. If an on-site service call is initiated, LI-COR will dispatch a service technician to the Buyer site. On-site service will be provided 8:00 a.m. to 5:00 p.m. (Buyer local time), Monday through Friday, excluding LI-COR holidays. The cost of a repair/service call for an instrument malfunction caused by third party hardware and/or software will be billed to Buyer on a time and material basis.

(e) Any Product that has either been repaired or replaced under this warranty shall have warranty coverage (parts only) for the longer of ninety (90) days or the remaining original warranty period. Replacement parts used in the repair of Products may be new or equivalent to new.

(f) EXCEPT FOR THE WARRANTIES SET FORTH IN THIS SECTION, LI-COR MAKES NO OTHER WARRANTIES, EXPRESS, IMPLIED OR STATUTORY, WITH RESPECT TO ANY PRODUCTS OR OTHER PRODUCTS PROVIDED IN CONNECTION WITH THESE CONDITIONS, INCLUDING WITHOUT LIMITATION ANY IMPLIED WARRANTY OF MERCHANTABILITY, FITNESS FOR A PARTICULAR PURPOSE, NONINFRINGEMENT, OR ARISING FROM COURSE OF PERFORMANCE, DEALING, USAGE OR TRADE.

(g) Notwithstanding anything herein to the contrary, LI-COR makes no warranty with respect to any third party products provided under these Conditions. Buyer's sole remedy with respect to such third party products shall be pursuant to the original manufacturer's or licensor's warranty, if any, to Buyer, to the extent permitted by the original manufacturer or licensor.

13. **Limitation of Liability.** IN NO EVENT SHALL LI-COR, ITS LICENSORS OR ITS SUPPLIERS BE LIABLE TO BUYER OR ANY THIRD PARTY FOR COSTS OF PROCUREMENT OF SUBSTITUTE PRODUCTS OR SERVICES, LOST PROFITS, DATA OR BUSINESS, OR FOR ANY INDIRECT, SPECIAL, INCIDENTAL, EXEMPLARY OR CONSEQUENTIAL DAMAGES OF ANY KIND ARISING OUT OF OR IN CONNECTION WITH THE USE OF THE PRODUCTS OR THESE CONDITIONS, HOWEVER CAUSED AND ON ANY THEORY OF LIABILITY (WHETHER IN CONTRACT, TORT (INCLUDING NEGLIGENCE), STRICT LIABILITY, PRODUCTS LIABILITY OR OTHERWISE). LI-COR TOTAL AND CUMULATIVE LIABILITY ARISING OUT OF OR IN CONNECTION WITH ANY PRODUCTS PURCHASED BY BUYER HEREUNDER SHALL IN NO EVENT EXCEED THE PURCHASE PRICE PAID BY BUYER FOR SUCH PRODUCTS. THE LIMITATIONS SET FORTH IN THIS SECTION SHALL APPLY EVEN IF LI-COR OR ITS SUPPLIERS HAVE BEEN ADVISED OF THE POSSIBILITY OF SUCH DAMAGES, AND NOTWITHSTANDING ANY FAILURE OF ESSENTIAL PURPOSE OF ANY LIMITED REMEDY.

14. **Authorized Use of Biotechnology Products.** Unless otherwise expressly indicated in LI-COR catalogues, LI-COR website or on the label or other documentation accompanying Biotechnology Products, the LI-COR Biotechnology Products are intended for RESEARCH USE ONLY and are not to be used for any other purposes including, but not limited to, unauthorized commercial purposes, in vitro diagnostic purposes, ex vivo or in vivo therapeutic purposes, investigational use, in foods, drugs, devices or cosmetics of any kind, or for consumption by or use in connection with or administration or application to humans or animals. Buyer acknowledges that the Biotechnology Products have not necessarily been tested for safety or efficacy, unless expressly stated in LI-COR catalogs or on the label or other documentation accompanying the Biotechnology Products.

15. **Authorized Use of Biotechnology Products.** Unless otherwise expressly indicated in LI-COR catalogues, LI-COR website or on the label or other documentation accompanying Biotechnology Products, the LI-COR Biotechnology Products are intended for RESEARCH USE ONLY and are not to be used for any other purposes including, but not limited to, unauthorized commercial purposes, in vitro diagnostic purposes, ex vivo or in vivo therapeutic purposes, investigational use, in foods, drugs, devices or cosmetics of any kind, or for consumption by or use in connection with or administration or application to humans or animals. Buyer acknowledges that the Biotechnology Products have not necessarily been tested for safety or efficacy, unless expressly stated in LI-COR catalogs or on the label or other documentation accompanying the Biotechnology Products.

16. **Severability.** If any portion of these Conditions is held invalid, the parties agree that such invalidity shall not affect the validity of the remaining portions of these Conditions.

17. **Export Control.** Buyer acknowledges and agrees that the Products purchased under these Conditions may be subject to restrictions and controls imposed by the United States Government and the regulations thereunder. BUYER WARRANTS THAT IT WILL NOT EXPORT OR RE-EXPORT ANY PRODUCTS PURCHASED WITHOUT PRIOR WRITTEN NOTIFICATION AND APPROVAL OF LI-COR.

18. **Assignment.** Buyer shall not assign or transfer these Conditions or any rights or obligations under these Conditions, whether voluntary or by operation of law, without the prior written consent of LI-COR. LI-COR may assign or transfer these Conditions to any successor by way of merger, acquisition or sale of all or substantially all of the assets relating to these Conditions. LI-COR or any successor may assign all or part of the right to payments under these Conditions. Any assignment or transfer of these Conditions made in contravention of the terms hereof shall be null and void. Subject to the foregoing, these Conditions shall be binding on and inure to the benefit of the parties' respective successors and permitted assigns.

19. **Entire Agreement.** These Conditions of Sale take precedence over Buyer's additional or different terms and conditions, to which notice of objection is hereby given. Acceptance by Buyer is limited to LI-COR Conditions of Sale. Neither LI-COR commencement of performance nor delivery shall be deemed or construed as acceptance of Buyer's additional or different terms and conditions. These Conditions supersede all prior communications, transactions, and understandings, whether oral or written, and constitute the sole and entire agreement between the parties

pertaining to the referenced quotation or purchase order, provided that: (1) these Conditions shall not, without LI-COR prior written consent, supersede any conflicting terms of: (a) prior written agreements duly executed by LI-COR, or (b) governmental purchase orders, terms of purchase, requests for quotation or acquisition regulations relative to governmental purchasers; and (2) to the extent not in conflict with any such prior or governmental terms, these Conditions shall supplement them. No modification, addition or deletion, or waiver of any of the terms and conditions of these Conditions shall be binding on either party unless made in a non-preprinted agreement clearly understood by both parties to be a modification or waiver, and signed by a duly authorized representative of each party.

20. Entire Agreement. These Conditions of Sale take precedence over Buyer's additional or different terms and conditions, to which notice of objection is hereby given. Acceptance by Buyer is limited to LI-COR Conditions of Sale. Neither LI-COR commencement of performance nor delivery shall be deemed or construed as acceptance of Buyer's additional or different terms and conditions. These Conditions supersede all prior communications, transactions, and understandings, whether oral or written, and constitute the sole and entire agreement between the parties pertaining to the referenced quotation or purchase order, provided that: (1) these Conditions shall not, without LI-COR prior written consent, supersede any conflicting terms of: (a) prior written agreements duly executed by LI-COR, or (b) governmental purchase orders, terms of purchase, requests for quotation or acquisition regulations relative to governmental purchasers; and (2) to the extent not in conflict with any such prior or governmental terms, these Conditions shall supplement them. No modification, addition or deletion, or waiver of any of the terms and conditions of these Conditions shall be binding on either party unless made in a non-preprinted agreement clearly understood by both parties to be a modification or waiver, and signed by a duly authorized representative of each party.

21. Force Majeure. Shipping dates are approximate and may be delayed absent prompt receipt from Buyer of all necessary information. LI-COR shall not be responsible for any failure to perform or delay attributable in whole or in part to any cause beyond its reasonable control, including but not limited to Acts of God, government actions, war, civil disturbance, insurrection, sabotage, labor shortages or disputes, failure or delay in delivery by LI-COR suppliers or subcontractors, transportation difficulties, customs clearance, shortage of energy, raw materials or equipment, or Buyer's fault or negligence. In the event of any such delay the date of delivery shall, at the request of LI-COR, be deferred for a period equal to the time lost by reason of the delay.

22. Governing Law and Venue. These Conditions and performance by the parties hereunder shall be construed in accordance with the laws of the State of Nebraska, U.S.A., without regard to provisions on the conflicts of laws.

Index

A

- air filter, 6-4
- air inlet, 1-2
- alarms, 4-15
- auto sync
 - clock, 4-6

B

- backpack kit, 1-5
- batteries, 2-2
 - about, 1-3
 - charging, 2-2
 - disposal, B-4
 - shipping, 2-12
 - warnings, B-4
- battery status, 2-9

C

- calibration, 4-10, 6-1
- cavity temperature, 4-13
- channels
 - Wi-Fi, B-3
- Chinese language, 4-5, 5-6
- configurations
 - high altitude, 3-9, 4-5
 - reduced flow rate, 3-4, 4-5
 - standard, 3-4, 4-5

- connecting, 2-4
 - local area network, 2-6
 - wireless, 2-5
- connecting a sample, 3-3
- connecting an air supply, 3-2
- connection issues, 5-2, 5-3

D

- data
 - exporting, 3-9
 - retrieving, 3-9
 - storage capacity, 3-9
- data files
 - about, 3-9
- DHCP, 4-7
- dimensions, C-3
- display panel, 2-9
- downloading data, 3-9
- dry-down chemical, 6-5

E

- English language, 4-5, 5-6
- error codes, 2-10
- export
 - data, 3-9

F

- files
 - data, 3-9

filter
air inlet, 6-4

H

high altitude configuration, 3-9, 4-5

I

installing, 3-13
IP address, 5-4

L

LAN, 2-6
language selection, 4-5, 5-6
laser pressure, 4-12
laser safety labels, B-1
laser temperature, 4-13
laser temperature shift, 4-13

M

memory
storage capacity, 3-9
mounting, 3-13

N

network, 4-7
network status, 2-9
network time protocol, 4-6
NTP, 4-6

O

OF-CEAS, 1-1, A-1

P

performance status, 4-11
power cable
DC cable, 1-2, 1-5, 2-3
universal AC-to-DC, 1-2, 1-3, 2-2
power supply, 2-2
powering on, 2-1
powering on and off, 1-2, 2-11
precision time protocol, 4-6
PTP, 4-6

purge, 6-5

R

records
storage capacity, 3-9
reduced flow rate
configuration, 3-4, 4-5
kit, 1-5
residual, 4-12
ring down time, 4-13
RJ-45 connector, 1-2

S

safety labels
laser, B-1
SD card error message, 2-10
serial number, 2-9
set IP address automatically, 4-7
settings, 4-11
shipping
batteries, 2-12
labels, 2-12
shipping the instrument, 2-12
size, C-3
software
updating, 4-4
software interface, 4-1
software version, 4-4
span calibration, 4-10
Spanish language, 4-5, 5-6
spectroscopy, 1-1, A-1
standard configuration, 3-4, 4-5
static IP address, 4-7
status
performance, 4-11
status codes, 2-10
storing, 2-12
SVC required, 2-10

T

thermal enclosure temperature, 4-13
thresholds, 4-15

time

- unix epoch, 3-12
- timezone, 3-11, 3-12
- troubleshooting, 5-1

W

- warnings, B-1
- water warning, 1-2
- Wi-Fi, 2-8, 4-8, B-3
- Wi-Fi status, 2-9
- wireless communication, B-3
- wireless networking, 4-8

Z

- zero calibration, 4-10

LI-COR Biosciences

4647 Superior Street
Lincoln, Nebraska 68504
Phone: +1-402-467-3576
Toll free: 800-447-3576 (U.S. and Canada)
envsales@licor.com

Regional Offices**LI-COR Biosciences GmbH**

Siemensstraße 25A
61352 Bad Homburg
Germany
Phone: +49 (0) 6172 17 17 771
envsales-gmbh@licor.com

LI-COR Biosciences UK Ltd.

St. John's Innovation Centre
Cowley Road
Cambridge
CB4 0WS
United Kingdom
Phone: +44 (0) 1223 422102
envsales-UK@licor.com

LI-COR Distributor Network:

www.licor.com/envdistributors

984-19432 • 03/2023

The LI-COR logo is displayed in a bold, italicized, white sans-serif font against a solid blue background. The letters 'LI-COR' are connected, with a registered trademark symbol (®) positioned to the right of the 'R'.