



Operating instructions

EE741

Flow meter

for compressed air and gases

YOUR PARTNER IN SENSOR TECHNOLOGY



ELEKTRONIK®
Ges.m.b.H.

E+E Elektronik® Ges.m.b.H. provides no warranty of any kind for this publication and accepts no liability for improper use of the products described.

This publication might contain technical inaccuracies or typographical errors. The content is revised regularly and is not subject to change management. The manufacturer reserves the right to modify or change its described products at any time.

© Copyright E+E Elektronik® Ges.m.b.H.
All rights reserved.

USA

FCC notice:

This device has been tested and found to comply with the conditions for a category B device according to part 15 of the FCC rules and regulations. These conditions were designed to provide adequate protection against EMI in a residential environment. This device generates, uses and can radiate high-frequency energy. If it is not installed and used in accordance with the operating instructions, it may cause electromagnetic interference to radio communications. However there is no guarantee that electromagnetic interference will not occur in a particular installation. If the device does cause electromagnetic interference to radio or television reception (this can be determined by turning the device off and on), the user is advised to remedy the interference with the following measures:

- Reorient or relocate the receiving antenna.
- Increase the distance between the device and receiver.
- Connect the device to a different circuit to that of the receiver.
- Consult the dealer or an experienced radio/TV technician.

Caution:

Any changes to the device not expressly approved by an EMI representative could void the user's authority to operate this device.

CANADA

ICES-003 notification:

This category B device complies with Canadian standard ICES-003.

CONTENT

1	General	4
1.1	Explanation of symbols	4
1.2	Safety instructions	4
1.2.1	Intended use	4
1.2.2	Mounting, start-up and operation	4
1.3	Environmental aspects	5
2	Product description	6
2.1	Modular design	6
2.1.1	Changing the pipe diameter	7
2.2	Functions	7
2.2.1	Analogue output (OUT 1)	7
2.2.2	Switch (alarm) outputs (OUT 1 and OUT 2)	7
2.2.3	Pulse output (OUT 2) and consumption meter	8
2.2.4	Setting the standard conditions	8
2.2.5	Low flow cut-off	8
3	Mechanical installation	9
3.1	Installation dimensions	9
3.2	Choosing the appropriate mounting location	9
3.2.1	Process pressure	9
3.3	Installation position	10
3.4	Inlet and outlet measurement path	11
3.5	Installation of the gauge mounting block	12
3.5.1	Operating the pipeline without transmitter	12
3.6	Mounting the transmitter unit into the gauge mounting block	12
4	Electrical installation	13
4.1	Connection diagram	13
4.1.1	Switch and pulse outputs	14
4.2	Bus output	14
4.2.1	M-Bus (Meter Bus)	14
4.2.2	Modbus RTU	15
4.3	USB configuration interface	16
5	Display	17
5.1	Measured value display	17
5.2	Display menu	18
6	Error messages	19
7	Maintenance	19
7.1	Removing the transmitter from the gauge mounting block	20
7.2	Cleaning the sensing head	20
7.3	Ordering guide for accessories	20
8	Technical data	21
8.1	Factory settings of the outputs	22

HARDWARE

1 General

This operation manual is part of the scope of supply and serves for ensuring proper handling and optimal functioning of the device.

The operation manual shall be read before commissioning the equipment and it shall be provided to all staff involved in transport, installation, operation, maintenance and repair.

The operation manual may not be used for the purposes of competition without the written consent of E+E Elektronik® and may not be forwarded to third parties. Copies may be made for internal purposes.

All information, technical data and diagrams included in these instructions are based on the information available at the time of writing.

1.1 Explanation of symbols



This symbol indicates safety information.

It is essential that all safety information is strictly observed. Failure to comply with this information can lead to personal injuries or damage to property. E+E Elektronik® assumes no liability if this happens.



This symbol indicates instructions.

The instructions shall be observed in order to reach optimal performance of the device.

1.2 Safety instructions

1.2.1 Intended use

The flow meter (device) is dedicated to the measurement of compressed air, non-corrosive and non-flammable gases in pipelines. Please consult the manufacturer before employing the device in wet or dirty gases.

The flow meter is appropriate for operation in pressurized systems up to 16 bar (232 psi) (PN16).

Installation, electrical connection, maintenance and commissioning may only be performed by qualified, trained and authorized staff.

Use other than described in the present operation manual may represent a security risk for people and the entire measuring chain and is therefore not permitted. The manufacturer may not be made liable for injuries damages caused by inappropriate or non-intended use or installation.

To prevent safety risks and damages, and assure full functionality of the device, the user shall strictly observe the start-up, inspection and maintenance steps described in this manual. Furthermore, the device may not be manipulated in any other way than described in these operating instructions, and may not be exposed to any excessive mechanical stress.

The flow meter may be operated only under the ambient conditions as defined in the technical data sheet. Use under other ambient conditions may lead to device malfunctions.

1.2.2 Mounting, start-up and operation

The flow meter has been produced under state of the art manufacturing conditions, has been thoroughly tested and has left the factory fulfilling all safety criteria. .

The manufacturer has taken all precautions to ensure safe operation of the device. The user must ensure that the device is set up and installed in a manner that does not have a negative effect on its safe use.

The user is responsible for observing all applicable safety guidelines, local and international, with respect to safe installation and operation on the device. This operating manual contains information and warnings that must be observed by the user in order to ensure safe operation.

- Mounting, start-up, operation and maintenance of the device may be performed by qualified staff only. Such staff must be authorized by the plant operator to carry out the mentioned activities.
- The qualified staff must have read and understood this operating manual and must follow the instructions contained within.
- All process and electrical connections shall be thoroughly checked by authorized staff before putting the system into operation.
- Do not install or start start-up a device supposed to be faulty. Make sure that such devices are not accidentally used by marking them clearly as faulty.
- A faulty device may only be investigated and possibly repaired by qualified, trained and authorized staff. If the fault cannot be fixed, the device shall be removed from the system.
- Service operations other than described in this operating manual may only be performed by the manufacturer.

Disclaimer

The manufacturer or his authorized agent can be only be held liable in case of willful or gross negligence. In any case, the scope of liability is limited to the corresponding amount of the order issued to the manufacturer. The manufacturer assumes no liability for damages incurred due to failure to comply with the applicable regulations, operating instructions or the operating conditions. Consequential damages are excluded from the liability.

1.3 Environmental aspects



Products from E+E Elektronik® are developed and manufactured observing of all relevant requirements with respect to environment protection. Please observe local regulations for the device disposal.



For disposal, the individual components of the device must be separated according to local recycling regulations. The electronics shall be disposed of correctly as electronics waste.

2 Product description

The EE741 flow meter operates on the thermal mass flow measurement principle and is suitable for measuring the flow of compressed air and gases in pipelines. It can be used for measuring the consumption of compressed air, nitrogen, helium, argon, oxygen, CO₂ or other non-corrosive and non-flammable gases.

The EE741 measures the volume flow under standard conditions. The standard conditions according to DIN 1343 (1013.25 mbar; 0 °C) are factory-set. Additionally, EE741 measures also the mass flow, the standardized flow and the temperature.

EE741 has two signal outputs which can be configured as an analogue output (current), switch output or pulse output for consumption metering.

The EE741 features an integrated consumption meter. The consumption volume can be shown on the display and is retained even if the supply voltage is interrupted.

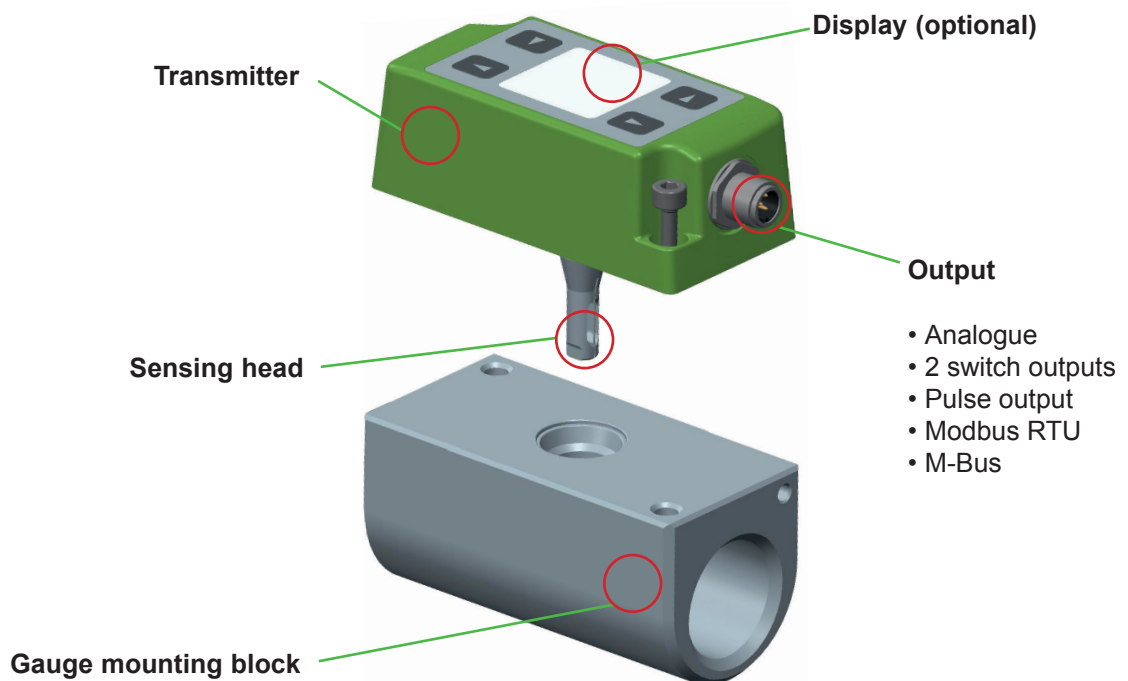

2.1 Modular design

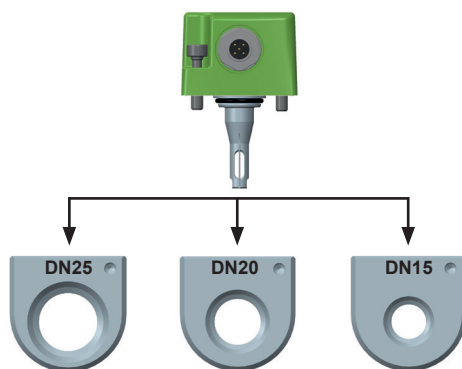

A single transmitter can be used for three different pipe diameters with the appropriate DN15, DN20 and DN25 gauge mounting blocks. The pipe diameter setting of the transmitter can be easily changed via the display menu or the configurator software.

Once the gauge mounting block is mounted in the pipeline, the transmitter can be installed and removed without disconnecting the pipeline. As a result, the EE741 is also ideal for temporary measurements or mobile use. The sealing plug included in the scope of supply allows for operating the compressed air or gas network even without the transmitter.

2.1.1 Changing the pipe diameter



Upon delivery, the factory setting of the transmitter corresponds to the pipe diameter as ordered. The setting must match the gauge mounting block. For use with a gauge mounting block of different diameter, the transmitter setting shall be correspondingly changed, otherwise it would lead to relevant measurement errors.



Fig. 1 Pipe diameter on gauge mounting block

The pipe diameter setting of the transmitter can be viewed on the status page of the optional display and can be changed using the “Pipe diameter” menu, see § 5, page 17. Alternatively, the pipe diameter setting can be viewed and changed using the EE-PCS Product Configurator Software.

2.2 Functions

2.2.1 Analogue output (OUT 1)

The analogue current output (factory setting 4...20 mA or 0...20 mA) is used for the actual flow or temperature measured values. The analogue output is freely configurable and scalable via the display menu or the EE-PCS Product Configurator Software.



The analogue output features an error message function according to NAMUR NE43. In the event of a faulty sensing head, the output signal will freeze at 21 mA.

2.2.2 Switch (alarm) outputs (OUT 1 and OUT 2)

The switch outputs can be set via the display menu or the EE-PCS Product Configurator Software. One can select between “hysteresis mode” or “window mode” as well as between normally closed (NC) or normally open (NO) contact.

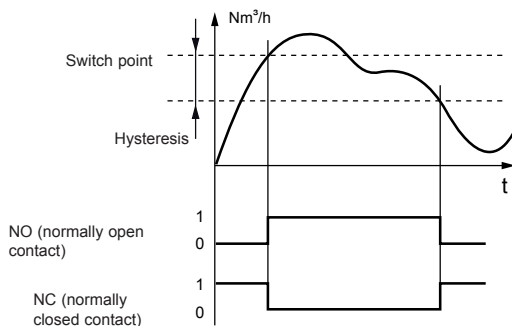

Fig. 2 Hysteresis mode

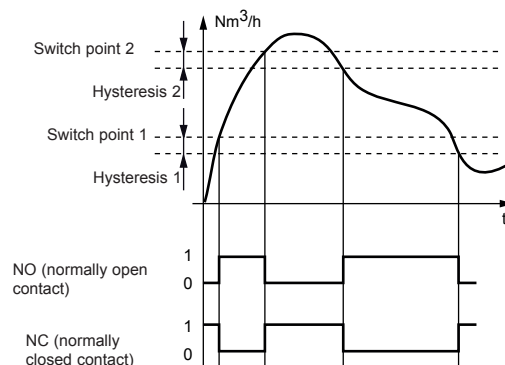

Fig. 3 Window mode

2.2.3 Pulse output (OUT 2) and consumption meter

The EE741 flow meter features an integrated meter with pulse output, which totalizes the consumption of compressed air or gas.

With the display menu or the EE-PCS Product Configurator Software the user can set:

- Pulse duration: 0.02...2 seconds
- Pulse value: 0.1...1,000 m³

The pulse - pause ratio must be at least 1:2. This means that the time between pulses must be at least twice the pulse duration.

The minimum time between two pulses is 2 s.

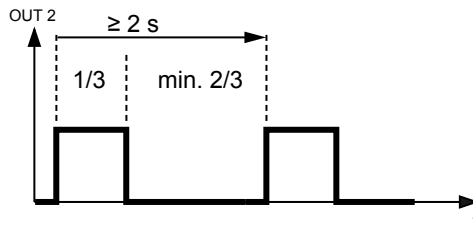

Fig. 4 Pulse-pause ratio

The pulse duration and the pulse value can be calculated with following MIN/MAX-Formula:

Calculating the min. “pulse value” or the max. “pulse duration”:

$$\text{IMPL_MIN} = \text{NORMV_MAX} [\text{m}^3/\text{h}] * \text{IMPL} [\text{s}] / 1200$$

$$\text{IMPL_MAX} = \text{IMPW} [\text{m}^3] * 1200 / \text{NORMV_MAX} [\text{m}^3/\text{h}]$$

IMPW	pulse value [m ³]
IMPL	pulse duration [s]
IMPL_MIN	min. value for pulse value [m ³]
IMPL_MAX	max. pulse duration [s]
NORMV_MAX	max. expected standard volume flow [m ³ /h]

The totalized consumption is stored every minute and is retained even if the supply voltage is interrupted.

The totalized consumption can be shown on the display. A reset of the consumption meter can be performed via display menu or via EE-PCS Product Configurator Software.

Maximum consumption value on the display:

The consumption value on the display is limited at 999,999,999.0 m³. Above this, the display shows “LCD maximum”, while the internally the consumption is metered normally till the maximum value of 3.4 * 10³⁸ m³. Values above 999,999,999.0 m³ can be read with the EE-PCS Product Configurator Software.

2.2.4 Setting the standard conditions

The standard volume flow calculation is based on the standard conditions stored in the EE741 transmitter unit. The factory setting for the standard conditions complies with DIN 1343:

$$P_0 = 1013.25 \text{ mbar}, t_0 = 0 \text{ }^\circ\text{C}$$

The standard conditions can be changed via display menu or via EE-PCS Product Configurator Software.

2.2.5 Low flow cut-off

Very small (insignificant) flow values can be suppressed by setting a shutdown threshold.

Measured values below the shutdown threshold have no effect on the output signal, display and consumption meter.

The minimum shutdown value can be set in m³/h or ft³/min.

3 Mechanical installation

3.1 Installation dimensions

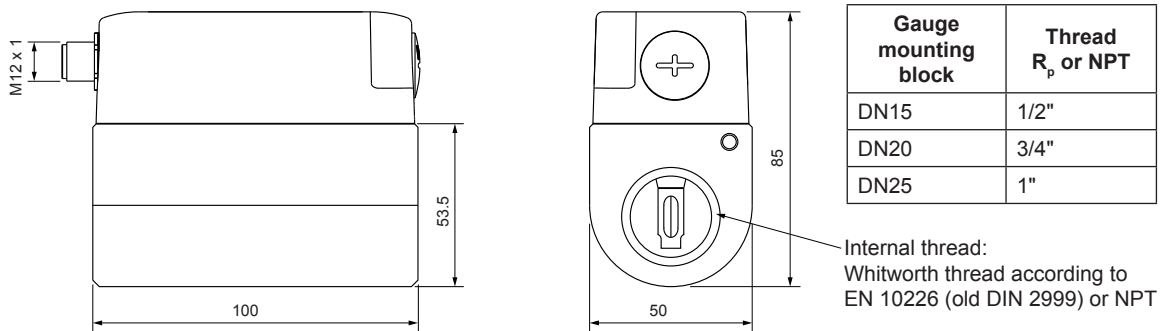

3.2 Choosing the appropriate mounting location



- The mounting location site shall be easily accessible and free of vibration.
- A minimum clearance of 120 mm (4.72") shall be observed around the mounting location for installing / removing the transmitter unit of the E741.
- The ambient temperature shall not exceed the specified limits. Consider also the possible heat radiation.
- Air (medium) purity at the mounting location shall comply to ISO 8573-1:2010, at least Class 3.4.4.
- The medium and the ambient conditions at the mounting location shall be non-condensing.
- In compressed air networks, EE741 shall be installed after the air dryer. In the absence of a dryer, EE741 shall be installed after the condensate separator and appropriate filters.
- Observe the flow direction in the pipe.
- Observe the recommended inlet and outlet path length. These are relevant for measurement accuracy as specified in the EE741 data sheet.
- EE741 shall be located as far as possible from flow disturbances, for instance at an appropriate distance before valves.

3.2.1 Process pressure



The pressure in the pipeline may not exceed 16 bar (232 psi).

Before mounting or removing the transmitter, the pipeline must be depressurised.

Due to its measuring principle, the measurement accuracy of the EE741 is quasi-independent of the actual process pressure. Besides, the device is factory adjusted at 7 bar (102 psi) absolute pressure. For normal requirements pressure compensation is not necessary. For best measurement accuracy, the actual working pressure can be set via display menu or via EE-PCS Product Configurator Software.

3.3 Installation position

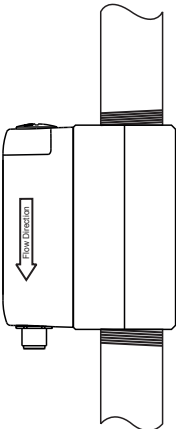
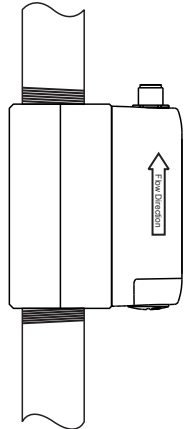
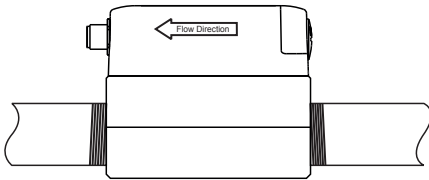
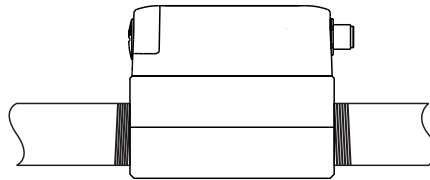
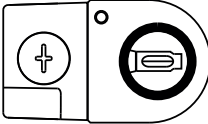
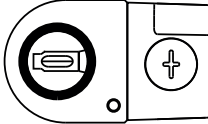
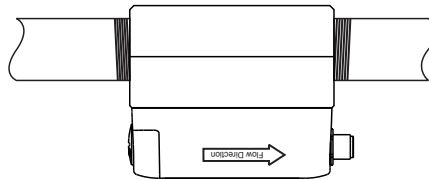
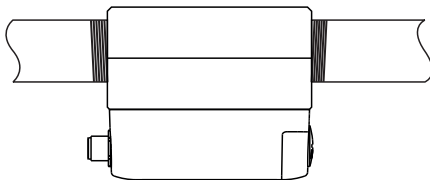
Vertical mounting		
		+
Horizontal mounting, transmitter at top		
		+
Horizontal mounting, transmitter horizontal		
		+
Horizontal mounting, transmitter at bottom		
		-



- + ... Recommended installation position
- Not recommended

3.4 Inlet and outlet measurement path

For measurement accuracy according to product specification, the EE741 flow meter shall be located as far as possible from flow disturbances caused for instance by pipe reductions or expansions, bends, T-pieces, valves or sliders. This can be accomplished by observing a minimum inlet and outlet path length, which depends on both the nature of disturbance and the pipe diameter.

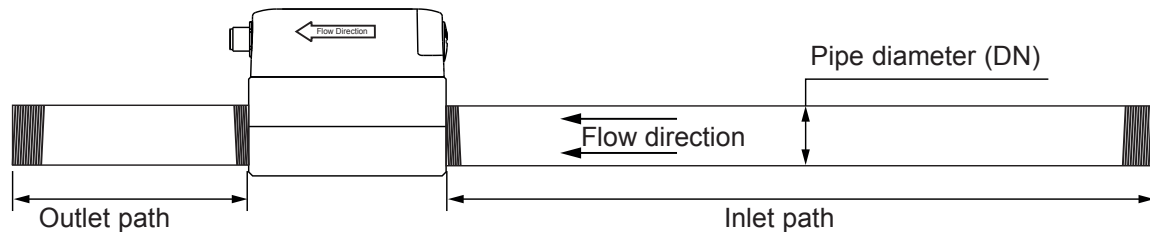
- The flowmeter shall be located before valves or sliders.
- With light gases the inlet paths need to be extended.

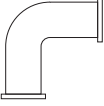
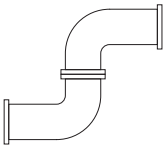
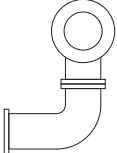
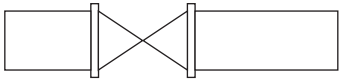

	Type	(DN = pipe diameter)	
		Inlet path	Outlet path
	Extension	15 x DN	5 x DN
	Reduction	15 x DN	5 x DN
	90° elbow	20 x DN	5 x DN
	Two 90° elbows, on one level	25 x DN	5 x DN
	Two 90° elbows, on two levels, T-piece	30 x DN	5 x DN
	Valve, slider	50 x DN	5 x DN

3.5 Installation of the gauge mounting block

The gauge mounting block is symmetrical and can be installed in the pipeline irrespective of the flow direction.



- All connections must be properly sealed and checked for tightness.
- The thread seals shall not impact on the cross section of the pipe or of the block.

3.5.1 Operating the pipeline without transmitter

To operate the pipeline without the transmitter unit, the opening of gauge mounting block which accommodates the sensing head can be closed using the sealing plug included in the scope of supply (fig. 5). The sealing plug has a Tuflok® coating (<http://www.bossard.com>) and does not require any additional seal.

Mount the sealing plug with a torque of min. 28 Nm.

Under normal operation with transmitter installed, the sealing plug shall be placed for safe keeping into the opening at the side of the gauge mounting block (fig.6).



Fig. 5 Gauge mounting block with sealing plugs



Fig. 6 Sealing plug in park position

3.6 Mounting the transmitter unit into the gauge mounting block



Depressurize the pipeline before mounting or removing the transmitter unit.

In case the gauge mounting block has been operated without transmitter, remove the sealing plug with a WAF 13 spanner.

Remove the protective cap from the sensing head (fig. 7) and insert carefully the sensing head of the transmitter into the gauge mounting block.

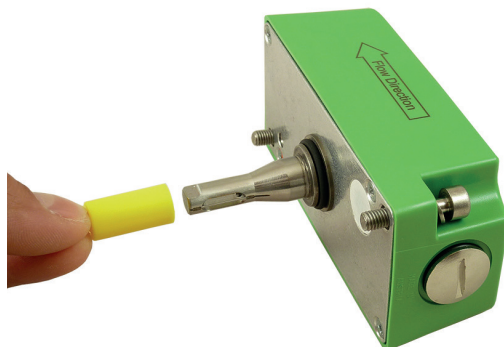

Fig. 7 Remove protective cap

Make sure that the direction arrow on the transmitter units corresponds to the flow direction in the pipeline. Failure to comply with this may lead to additional measurement error of $\pm 3\%$ of the measured value.

Complete the mounting by tightening the mounting screws with max. torque 6 Nm using the 4 mm hex key included in the scope of supply (fig. 8).



Fig. 8 Tighten mounting screws

4 Electrical installation



The electrical installation of the EE741 shall be performed by qualified staff only. Observe all applicable national and international requirements for the installation of electrical devices as well as power supply according to EN 50178, SELV, PELV.

4.1 Connection diagram



M12 4-pin connector according to IEC 61076-2-101

Fig. 9 M12 connector

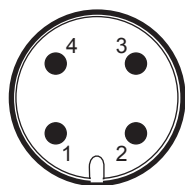

M12 connector on the transmitter

Analogue/switch/
pulse output

1...V+
2...Output 1
3...GND
4...Output 2

Modbus RTU

1...V+
2...RS485 A (=D+)
3...GND
4...RS485 B (=D-)

M-Bus / Meter bus

1...V+
2...M-Bus
3...GND
4...M-Bus

4.1.1 Switch and pulse outputs

Switch and pulse outputs are NOT potential-free and include internal pull-down resistors (fig.10)

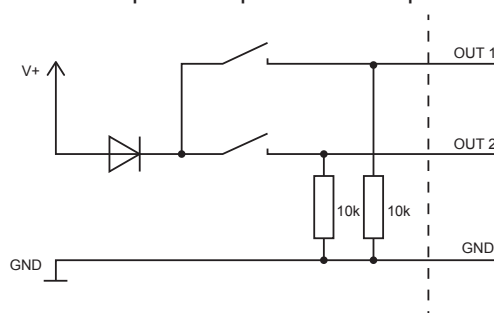

Fig. 10 Switch/pulse output

4.2 Bus output

4.2.1 M-Bus (Meter Bus)

The M-Bus (Meter Bus) is a field bus for recording consumption data. Transmission runs serially on a reverse polarity protected two-wire line. The EE741 flow meter as M-Bus slave requires a separate supply voltage. There is no prescribed specific topology (line or star) for the wiring. Normal phone cable of type J-Y(St)Y Nx2x0.8 mm can be used. The max cable length per segment (primary addressed) is 250 m (3.28 ft).

The table below shows the structure of the consumption data sent by the transmitter:

Header	
68	Start of the telegram
4F 4F	L-field (length)
68	Second starting signal
08	C-field (RSP_UD)
XX	A-field (address)
Start user data	
72	CI-field (variable data structure)
XX XX XX XX	Identification number
A5 16	Manufacturer (0x16A5 ... EUE)
01	Version
00	Medium (0 ... others)
XX	Access number (consecutive)
00	Status
00 00	Signature
Data record 1: Volume flow	
05	DIF (32 bit real)
3E	VIF (volume flow in m ³ /h)
XX XX XX XX	Cur. measured value
Data record 2: Temperature	
05	DIF (32 bit real)
5B	VIF (temperature in °C)
XX XX XX XX	Cur. measured value
Data record 3: Mass flow	
05	DIF (32 bit real)
53	VIF (mass flow in kg/h)
XX XX XX XX	Cur. measured value
Data record 4: Consumption meter status	
05	DIF (32 bit real)
16	VIF (volumes in m ³)
XX XX XX XX	Cur. consumption value

Data record 5: Flow velocity	
05	DIF (32 bit real)
7F	VIF (manufacturer-specific in m/s)
XX XX XX XX	Cur. measured value
Data record 6: Volume flow	
04	DIF (32 bit integer)
3B	VIF (volume flow in 10 ⁻³ m ³ /h)
XX XX XX XX	Cur. measured value
Data record 7: Temperature	
04	DIF (32 bit integer)
59	VIF (temperature in 10 ⁻² °C)
XX XX XX XX	Cur. measured value
Data record 8: Mass flow	
04	DIF (32 bit integer)
51	VIF (mass flow in 10 ⁻² kg/h)
XX XX XX XX	Cur. measured value
Data record 9: Consumption meter status	
07	DIF (64 bit integer)
13	VIF (volumes in 10 ⁻³ m ³)
XX XX XX XX	Cur. consumption value
XX XX XX XX	
Data record 10: Flow velocity	
04	DIF (32 bit integer)
7F	VIF (manufacturer-specific in 10 ⁻² m/s)
XX XX XX XX	Cur. measured value
End user data	
XX	Checksum
16	End of telegram

Secondary addressing:

In addition to primary addressing, the EE741 flow meter provides the option of secondary addressing. The secondary address uses the fields of identification number, manufacturer, version and medium. The M-Bus Standard <http://www.m-bus.com/files/MBDOC48.PDF> describes the exact sequence of the secondary addressing.

Data transmission:

	Factory settings	Adjustable values
Baud rate	9600	600, 1200, 2400, 4800, 9600
Data bits	8	8
Parity	NONE	None, odd, even
Stop bits	1	1 or 2
Slave address	240	0...254



For several devices on the bus the max. recommended baud rate is 9600.

4.2.2 Modbus RTU

EE741 flow meter can be operated in a Modbus RTU network with max. 32 devices. Writing 0 into the corresponding register will reset the MIN/MAX values and the consumption meter.

For Modbus protocol settings see Application Note Modbus AN0103 (www.epluse.com/EE774).

Modbus Map:

Register [DEC]	Protocol address [HEX]	Measured value	Unit	Type
Read registers (function code 0x03 / 0x04)				
30501	1F4	Temperature	°C	32-bit float
30503	1F6	Temperature	°F	32-bit float
30507	1FA	Standard flow	Nm/s	32-bit float
30509	1FC	Standard flow	SFPM	32-bit float
30511	1FE	Mass flow	kg/h	32-bit float
30513	200	Mass flow	kg/min	32-bit float
30517	204	Standard volume flow	Nm³/h	32-bit float
30519	206	Standard volume flow	Nm³/min	32-bit float
30521	208	Standard volume flow	l/min	32-bit float
30523	20A	Standard volume flow	l/s	32-bit float
30525	20C	Standard volume flow	SCFM	32-bit float
30529	210	Consumption meter status	m³	64-bit-double
30533	214	Consumption meter status	ft³	64-bit-double
31001	3E8	MIN value temperature	°C	32-bit float
31003	3EA	MIN value temperature	°F	32-bit float
31007	3EE	MIN value standard flow	Nm/s	32-bit float
31009	3F0	MIN value standard flow	SFPM	32-bit float
31011	3F2	MIN value mass flow	kg/h	32-bit float
31013	3F4	MIN value mass flow	kg/min	32-bit float
31017	3F8	MIN value standard volume flow	Nm³/h	32-bit float
31019	3FA	MIN value standard volume flow	Nm³/min	32-bit float
31021	3FC	MIN value standard volume flow	l/min	32-bit float
31023	3FE	MIN value standard volume flow	l/s	32-bit float
31025	400	MIN value standard volume flow	SCFM	32-bit float
31501	5DC	MAX value temperature	°C	32-bit float
31503	5DE	MAX value temperature	°F	32-bit float
31507	5E2	MAX value standard flow	Nm/s	32-bit float
31509	5E4	MAX value standard flow	SFPM	32-bit float
31511	5E6	MAX value mass flow	kg/h	32-bit float
31513	5E8	MAX value mass flow	kg/min	32-bit float
31517	5EC	MAX value standard volume flow	Nm³/h	32-bit float
31519	5EE	MAX value standard volume flow	Nm³/min	32-bit float
31521	5F0	MAX value standard volume flow	l/min	32-bit float
31523	5F2	MAX value standard volume flow	l/s	32-bit float
31525	5F4	MAX value standard volume flow	SCFM	32-bit float

Write registers (function code 0x06)				
60001	0	Reset MIN value temperature		16-bit integer
60002	1	Reset MIN value standard flow		16-bit integer
60003	2	Reset MIN value mass flow		16-bit integer
60004	3	Reset MIN value standard volume flow		16-bit integer
60005	4	Reset MAX value temperature		16-bit integer
60006	5	Reset MAX value standard flow		16-bit integer
60007	6	Reset MAX value mass flow		16-bit integer
60008	7	Reset MAX value standard volume flow		16-bit integer
60009	8	Reset consumption meter		16-bit integer

Data transmission:

	Factory settings	Adjustable values
Baud rate	9600	9600, 19200, 38400
Data bits	8	8
Parity	NONE	None, odd, even
Stop bits	1	1 or 2
Slave address	240	1...247



The recommended baud rate for several devices in the Modbus RTU network is 9600.

Bus termination resistor:



Bus termination is required for the last flow meter in a Modbus RTU network. The 120 Ohm termination resistor is located behind the blind of the USB port and can be switched on and off (fig. 11)



Fig. 11 Bus termination resistor

4.3 USB configuration interface

The micro USB port is located behind a blind cover (fig. 12 and 13)

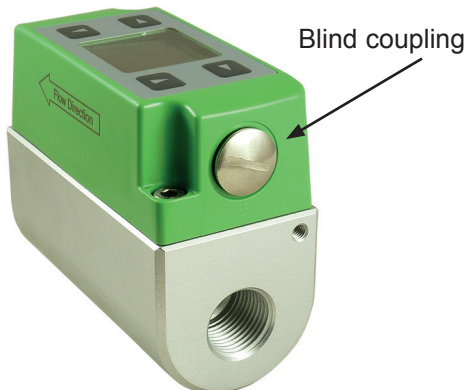

Fig. 12 Remove the blind cover



Fig. 13 Plug in the USB cable



For EE741 setup and configuration via USB interface it is necessary to install the EE-PCS Product Configuration Software on a personal computer. EE-PCS is available for free download at www.epluse.com/EE741.

5 Display

The LCD-display (optional) shows the actual measured values and the overall consumption. The complete EE741 setup and configuration can be performed with the control keys and intuitive, self explanatory menu guidance.



If the settings are changed during operation, it may affect the function of the system. Ensure that it will not result in any system malfunctions.

The display orientation can be changed in 90° steps via the settings menu to match the mounting position of EE741 (fig. 14 and 15)



Fig. 14 Horizontal display



Fig. 15 Vertical display

5.1 Measured value display

Upon power on the display is in measuring mode and shows the measured values. One can select among six measurands and a status page (fig. 16 and 17).

Abbreviations for measurands:

T ... Temperature
V'n ... Standard volume flow
m' ... Mass flow
Qn ... Consumption
vn ... Standard flow

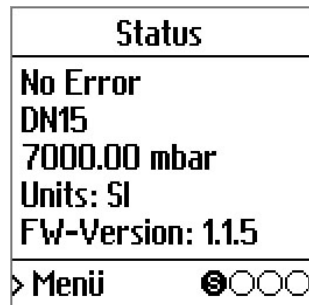

Fig. 16 Status display

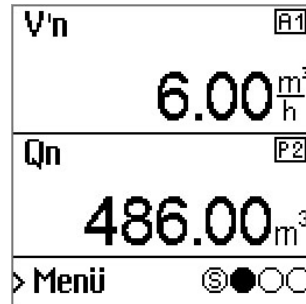

Fig. 17 Measured value display

Explanation of the symbols:

- ... Output 1 set to analogue output
- ... Output 2 set to pulse output/consumption
- ... Output 1 set to switching output; status OFF
- ... Output 1 set to switching output; status ON
- ... Output 2 set to switching output; status OFF
- ... Output 2 set to switching output; status ON

5.2 Display menu

The display menu can be navigated and settings made using the four control keys allow for easy navigation and intuitive device setup.

- ... SELECT/SAVE
- ... BACK/CANCEL
- ... UP/increase value
- ... DOWN/decrease value

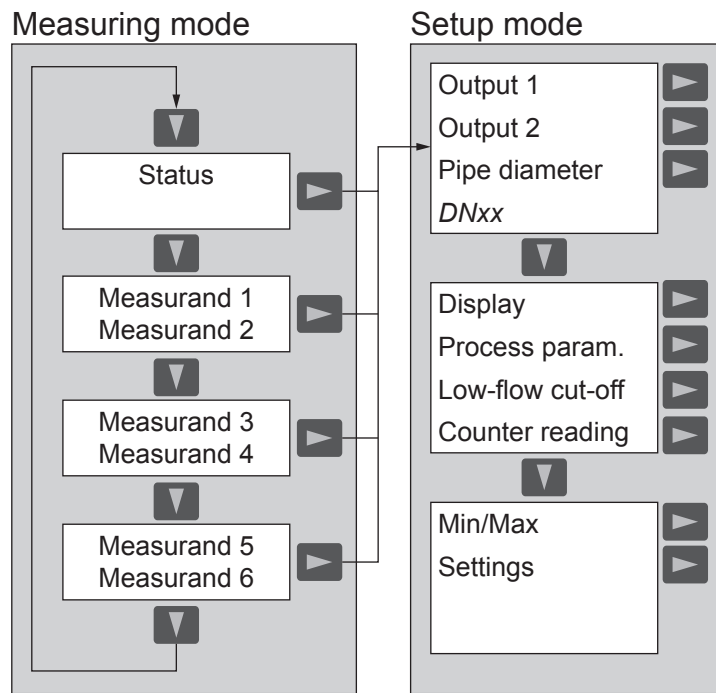

Fig. 18 Display - menu guidance

Output 1

Configuration for output 1: analogue or switch output, measurand, scale and switch setup.

Output 2

Configuration for output 2: switch or pulse output, measurand, switch setup.

Pipe diameter

Set the pipe diameter, see 2.1.1 on page 7

Display

Set the measuring mode and the display orientation.

Process parameter

Set the operating pressure and the standard conditions (see 2.2.4, page 8).

Low-flow cut-off

Set the cut-off threshold for leak flow volume suppression, (see 2.2.5, page 8).

Counter reading

Display or reset the consumption meter.

Min/Max

Display or delete the min/max memory.

Settings

- Set the language.
- Set the averaging for measured value of the analogue output signal between 1 and 50. The measuring rate is 0.1 seconds).
The response time $t_{90} < 2$ seconds according to the specs is achieved for averaging less than 10 values. With averaging 50 values the response time is 5 seconds.

6 Error messages

Error messages are available on the status page of the display and at the status LEDs.

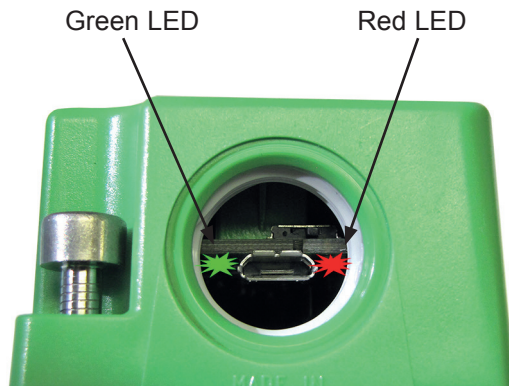

Fig. 19 Status LED - error message

0: no error / green LED flashes

1: EEPROM faulty / green LED flashes, red LED lights up

Cause: The EEPROM for storing the consumption meter status and the MIN/MAX values is faulty.

Consequence: The consumption meter status and the MIN/MAX values are no longer available. All current measured values are shown on the display. The analogue, switch and pulse outputs operate normally.

Remedy: Return the device to the manufacturer for service.

2: Display error / green LED flashes, red LED lights up

Cause: The display or the communication with the display is faulty.

Consequence: Analogue, switch and pulse outputs operate normally.

Remedy: Return the device to the manufacturer for service.

4: Sensor fault / green LED flashes, red LED flashes

Cause: The sensing head is faulty.

Consequence: All measurands on the display are frozen at the lowest possible value e.g. $-20\text{ }^{\circ}\text{C}$ ($-4\text{ }^{\circ}\text{F}$) or $0\text{ m}^3/\text{h}$. The analogue output is frozen at 21 mA (NAMUR NU43).

Remedy: Return the device to the manufacturer for service.

7 Maintenance

It is recommended to calibrate the EE741 flowmeter on a yearly base.

For use with polluted media, the sensing head should be periodically cleaned.

7.1 Removing the transmitter from the gauge mounting block



Depressurize the pipeline before mounting or removing the transmitter unit.

Ensure that the line is depressurized and release the mounting screws of the transmitter unit (fig. 20 and 21).



Fig. 20 Unscrew mounting screws



Fig. 21 Remove transmitter

To operate the pipeline without a transmitter, see 3.5.1 on page 12

7.2 Cleaning the sensing head



Do not use abrasive cleaning agents and organic solvents containing halogen or acetone.

Clean the sens head by carefully dipping into warm water or isopropanol. Isopropanol is recommended for contamination with greases or oils.



Do not touch or rub the sensor element within the sensing head.

Allow the sensing head to dry free.

7.3 Ordering guide for accessories

Designation		Order number
Inlet and outlet path BSP thread, stainless steel for gauge mounting block	DN15	HA070215
	DN20	HA070220
	DN25	HA070225
M12 female connector for self assembly, plastic		HA010707
M12 female connector for self assembly, metal		HA010708
Connecting cable, M12x1 socket - free ends, shielded, PUR	1.5 m	HA010819
	5 m	HA010820
	10 m	HA010821
Connecting cable, M12x1 socket - connector, shielded, PUR	2 m	HA010816
	5 m	HA010817
	10 m	HA010818
Sealing plugs for the gauge mounting block (for operating the pipeline without the transmitter unit)		HA070204

8 Technical data

Measured values

Flow

Measurands	m ³ /h, m ³ /min, l/min, l/s, kg/h, kg/min, m/s, SCFM, ft/min, °C, °F
Standard conditions (factory setting)	1013.25 mbar (14.7 psi), 0 °C (32 °F) (configurable)
Measuring range in air	DN15: 0.2...76.3 Nm ³ /h (0.12...44.88 SCFM) DN20: 0.4...135.6 Nm ³ /h (0.24...79.77 SCFM) DN25: 0.6...212 Nm ³ /h (0.36...124.71 SCFM)
Accuracy ¹⁾ in air at 7 bar (102 psi) (abs) and 23 °C (73 °F)	± (3 % of measured value + 0.3 % of full scale)
Temperature coefficient	± 0.25 % of the measured value / °C deviating from 23 °C (73 °F)
Pressure coefficient ²⁾	+ 0.5 % of the measured value / bar deviating from 7 bar (102 psi)
Response time t ₉₀	< 2 sec
Measuring rate	0.1 sec

Temperature

Measuring range	-20...60 °C (-4...140 °F)
Accuracy at 20 °C (68 °F) and flow >0.5 Nm/s	± 0.7 °C (1.26 °F)

Outputs

Analogue output (scalable)	0 - 20 mA / 4 - 20 mA, R _i < 500 Ohm
Switch output	DC PNP, max. 100 mA, V _{drop} < 2.5 V, 10 kOhm pull-down Configurable: N/C or N/O, hysteresis, window
Pulse output	Consumption volume meter, pulse duration 0.02...2 sec.
Bus interface	Modbus RTU (max. 32 bus devices) or M-BUS (Meter-Bus)
Configuration interface	USB

General

Supply voltage	18 - 30 V DC
Current consumption (max.)	
with display	I _{max} ≤ 120 mA (P _{max} ≤ 2.5 W)
without display	I _{max} ≤ 60 mA (P _{max} ≤ 1.6 W)
Operating pressure (max.)	16 bar (232 psi) / PN16
Ambient temperature	
with display	-10...50 °C (14...122 °F)
without display	-20...60 °C (-4...140 °F)
Medium and storage temperature	-20...60 °C (-4...140 °F)
Humidity	0...100 % rH, non-condensing
Medium	Compressed air, nitrogen, oxygen, helium, CO ₂ , argon
Electrical connection	M12x1 4 pin plug
Electromagnetic compatibility	EN61326-1 EN61326-2-3 Industrial environment
Material	
Enclosure	Polycarbonate
Probe tube	Stainless steel 1.4404
Probe head / sensor	Stainless steel 1.4404 / glass
Measuring block	Aluminium anodised or stainless steel 1.4404
Enclosure protection class	IP65



1) The tolerance specifications include the uncertainty of the factory calibration with a coverage factor k=2 (2 x standard deviation). The tolerance was calculated in accordance with EA-4/02 following the GUM (Guide to the Expression of Uncertainty in Measurement).

2) The flow meter was adjusted at 7 bar (102 psi) (abs). At an operating pressure other than 7 bar (102 psi) (abs), the error can be corrected by entering the actual system pressure (display menu or configurator software).

8.1 Factory settings of the outputs

	Pipe diameter	Analogue output		Switch output hysteresis mode		Minimum flow shutdown	
		from	to	SP	HY	SP	HY
Standard volume flow [Nm ³ /h]	DN15	0	75	50	5	0.15	0.07
	DN20	0	130	90	9	0.25	0.12
	DN25	0	200	150	15	0.35	0.17
Standard volume flow [Nm ³ /min]	DN15	0	1.25	0.83	0.08		
	DN20	0	2.15	1.5	0.15		
	DN25	0	3.3	2.5	0.25		
Standard volume flow [l/min]	DN15	0	1250	833	83		
	DN20	0	2150	1500	150		
	DN25	0	3300	2500	250		
Standard volume flow [l/s]	DN15	0	20	14	1.4		
	DN20	0	35	25	2.5		
	DN25	0	55	40	4		
Standard volume flow [SCFM]	DN15	0	44	30	3	0.1	0.05
	DN20	0	76	53	5.3	0.15	0.07
	DN25	0	117	88	8.8	0.2	0.1
Mass flow [kg/h]	DN15	0	97	65	6.5		
	DN20	0	165	115	11.5		
	DN25	0	255	195	19.5		
Mass flow [kg/min]	DN15	0	1.6	1	0.1		
	DN20	0	2.8	2	0.2		
	DN25	0	4.3	3.2	0.32		
Standard flow [Nm/s]	DN15	0	120	80	8		
	DN20	0	120	80	8		
	DN25	0	120	80	8		
Standard flow [SCFM]	DN15	0	23600	15000	1500		
	DN20	0	23600	15000	1500		
	DN25	0	23600	15000	1500		
Temperature [°C]	DN15	-20	60	24	0.5		
	DN20	-20	60	24	0.5		
	DN25	-20	60	24	0.5		
Temperature [°F]	DN15	-4	140	75	1		
	DN20	-4	140	75	1		
	DN25	-4	140	75	1		

Pulse output:

Pulse duration: 0.1 sec

Pulse value: 1 m³

Measured value averaging: 10



COMPANY HEADQUARTERS

E+E ELEKTRONIK Ges.m.b.H.

www.epluse.com
Langwiesen 7
A-4209 Engerwitzdorf
Austria
Tel: +43 7235 605 0
Fax: +43 7235 605 8
info@epluse.com

TECHNICAL OFFICES

E+E CHINA **www.epluse.cn**

BEIJING
Tel: +86 10 84992361
info@epluse.cn
SHANGHAI
Tel: +86 21 61176129
info@epluse.cn

E+E GERMANY
www.epluse.de
Tel: +49 6172 13881 0
info@epluse.de

E+E FRANCE
www.epluse.fr
Tel: +33 4 7472 35 82
info@epluse.fr

E+E ITALY
www.epluse.it
Tel: +39 02 2707 8636
info@epluse.it

E+E KOREA
www.epluse.co.kr
Tel: +82 31 732 6050
info@epluse.co.kr

E+E USA
www.epluse.com
Tel: +1 508 530 3068
office@epluse.com

YOUR PARTNER IN SENSOR TECHNOLOGY



ELEKTRONIK®
Ges.m.b.H.